

235 / 252

235, 252

mara[®]

DESCRIPTION / DESCRIZIONE

en Mara offers different solutions of central base tables to complete the other collection.

Made of durable and easy to maintain materials, they are available in a wide range of shapes, sizes and finishes.

They are an ideal solutions for cafeterias, bistros, restaurants and office spaces.

it Mara affianca alle proprie collezioni diverse soluzioni di tavoli a base centrale.

Realizzati con materiali durevoli e di facile manutenzione sono disponibili in un'ampia gamma di forme, dimensioni e finiture.

Tavoli ideali per essere utilizzati in caffetterie, bistrot, ristoranti ma anche in ambienti ufficio.

235

235

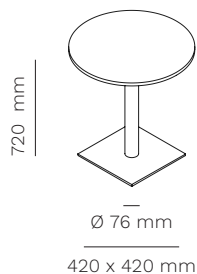

top
Ø 500 - 900 mm
500 x 900 mm



235
17,9 kg

252

252

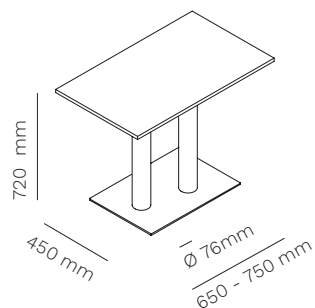

top
700 -1200 X 500 - 800 mm



252
34 kg



outdoor version
versione outdoor



**version with FSC®
certified top**
versione con piano
certificato FSC®

ACCESSORIES / ACCESSORI



foot levelers
piedini livellatori

FRAME AND METAL TOP / STRUTTURA E PIANO

powder coated steel frame and metal top
telaio in metallo e piano in lamiera verniciati



FRAME AND METAL TOP / STRUTTURA E PIANO



powder coated steel frame and metal top for outdoor
telaio in metallo e piano in lamiera verniciati per outdoor



TOP / PIANO

standard colour and material effect laminate tops
piani standard in laminato colore ed effetto materico



STANDARDS AND CERTIFICATES / NORME E CERTIFICATI
Dimensional tolerance related to the thickness $\pm 0,3$ mm •
Dimensional tolerance related to the sizes $\pm 5,0$ mm • Resistance to scratching EN 438-2:2016 Class 3 • Resistance to staining EN 438-2:2016 Group 1 e 2: Class ≥ 4 Group 3: Class ≥ 4 • Resistance to dry heat (160°C/20') - EN 438-2 Class 4 • Lightfastness (xenon arc) EN 438-2 Grayscale classification ≥ 4

• Resistance to steam EN 438-2 Class 4 • Resistance to surface wear EN 438-2 Rotation value IP ≥ 150 • Resistance to damp heat (100°C/20') - EN 438-2 Class 4

TOP / PIANO

standard colour and wood melamine tops

piani standard in nobilitato colore e legno

white
bianco

magnolia

light grey
grigio
chiaroanthracite
antraciteblack
nerowhitened
oak
rovere
sbiancatonatural
oak
rovere
naturalegrey
oak
rovere
grigioblack
oak
rovere
nerowalnut
noce

STANDARDS AND CERTIFICATES / NORME E CERTIFICATI

Dimensional tolerance related to the sizes $\pm 5,0$ mm • Resistance to scratching 1,5 N • Resistance to cigarette burning 3 grade - moderate change in gloss level and/or moderate brown spots • Resistance to surface wear Rotation value IP < 50 • Rotation value WR < 150 • Risk of breakage ≥ 3 group • Dimensional tolerance related to the thickness $15 \leq X \leq 20$ mm : $\pm 0,3$ mm X < 20 mm : $\pm 0,5$ mm • Resistance to staining ≥ 3 group

• Resistance to steam 4 grade - moderate change in gloss level and/or color • Surface imperfections Prolate imperfections: < 20 mm/m Punctiform imperfections: < 2 mm²/m² • Lightfastness (xenon arc) > 6 group

standard hpl top for outdoor use (black edge)

piani standard in hpl per uso outdoor (bordo nero)

white
biancolight grey
grigio
chiaroanthracite
antraciteblack
nero

CLEANING AND MAINTENANCE / PULIZIA E MANUTENZIONE

STEEL / ACCIAIO

en Our types of metals include: **chromed metals and painted metals. Do not use acid or alkaline based cleaning products. Do not use detergents, steel wool, dishwashing detergents or the like. Sharp or pointed objects may damage the surface. Any hot or wet object may cause surface damage. Clean the surface regularly with a soft cloth to remove dust. To remove light dirt, use a soft cloth and a neutral household cleaner.**

it Le nostre PEPEologie di metallo comprendono: metalli cromati e metalli verniciati. Non utilizzare prodotti per la pulizia a base acida o alcalina. Non utilizzare detergenti, lana di acciaio, detersivi per stoviglie o simili. Oggetti appuntiti o taglienti possono danneggiare la superficie. Qualsiasi oggetto caldo o bagnato potrebbe provocare danni alla superficie. Pulire la superficie regolarmente con un panno soffice per rimuovere la polvere. Per rimuovere lo sporco leggero utilizzare un panno soffice e un prodotto per le pulizie di casa neutro.

LAMINATE AND MELAMINE / LAMINATI E NOBILITATI

en Laminates and melamine products guarantee high performance in terms of resistance to scratches, shocks and abrasions. Keep furniture away from direct sunlight; furniture in direct sunlight may tend to discolour over time. Do not use acid or alkaline based cleaning products. Sharp or pointed objects can damage the surface. Laminate and melamine furniture can be cleaned using a mixture of liquid soap and hot water. Rinse with cold water and dry with a paper towel or damp cloth.

it Laminati e nobilitati garantiscono alte prestazioni di resistenza ai graffi, agli urti e alle abrasioni. Mantenere i mobili lontani dalla luce diretta del sole; i mobili che si trovano alla luce diretta del sole potrebbero tendere a scolorire nel tempo. Non utilizzare prodotti per la pulizia a base acida o alcalina. Oggetti appuntiti o taglienti possono danneggiare la superficie. E' possibile effettuare la pulizia dei mobili in laminato e nobilitato usando una miscela di sapone liquido e acqua calda. Sciacquare con acqua fredda e asciugare con un tovagliolo di carta o un panno umido.



en All the energy used in our company is 100% green and comes exclusively from renewable sources.

it Tutta l'energia utilizzata nella nostra azienda è 100% GREEN e proviene esclusivamente da fonti rinnovabili.

en As it is always seeking to improve its products, the company reserves the right to modify or upgrade the products without prior notice, at any time. Colors should be considered purely indicative. Mara's Collections are worldwide protected by the industrial property right and patents.

it Mara, sempre alla ricerca del miglioramento dei propri prodotti, si riserva la facoltà di apportare modifiche costruttive e funzionali in qualsiasi momento senza alcun preavviso. I colori dei materiali sono da ritenersi puramente indicativi. Tutte le collezioni Mara sono protette nel mondo dal diritto di proprietà industriale e da brevetti registrati.