

DESCRIPTION / DESCRIZIONE

en The Foil table appears as “a top with four legs”, all in metal. There is no complexity on sight, no articulated structure, no overexposure in form or technique: just a flat surface bordered by a minimal frame and supported by four ultra-thin legs.

Also available as Desk, Bench and Workstation with sliding top and storage space underneath.

The frame, in fact, is not only an aesthetic detail, it serves to conceal the mechanical system, as well as any accessories that Foil may be equipped with, like the practical drawers.

it Il tavolo Foil appare come “un piano con quattro gambe”, tutto in metallo. Non c'è complessità alla vista, nessuna struttura articolata, nessun esibizionismo nelle forme o nella tecnica: solo una superficie piana delimitata da una cornice minima e sostenuta da quattro gambe dagli spessori ultra sottili.

Disponibile anche nelle versioni Desk, Bench e Workstation con piano che trasla e rivela lo spazio portacavi.

La cornice, oltre ad essere un dettaglio estetico, è funzionale a celare il sistema meccanico, così anche eventuali accessori di cui Foil può essere dotato, a partire dai pratici cassetti.

FOIL
fixed table
tavolo fisso

211

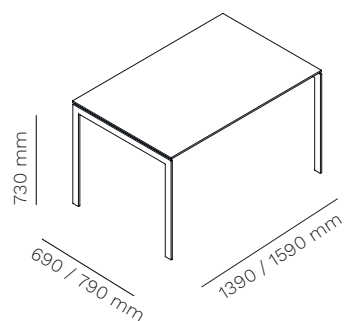

top
1390/1590 x 690/790 mm



version with
FSC® certified top
versione con piano
certificato FSC®

ACCESSORIES / ACCESSORI

211C40

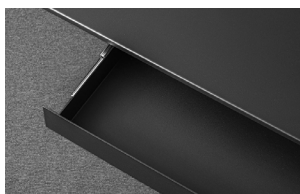

Small metal drawer 385 mm
Cassetto piccolo in metallo
385 mm

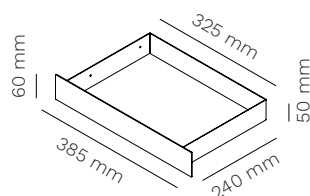

211C60

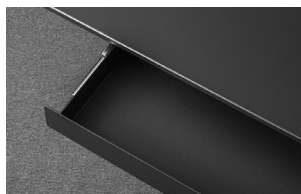

Big metal drawer 585 mm
Cassetto grande in metallo
585 mm

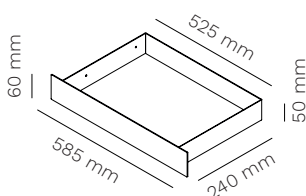

211V140



**Cable tray for table top
1400 mm**
Vasca portacavi per piano
da 1400 mm

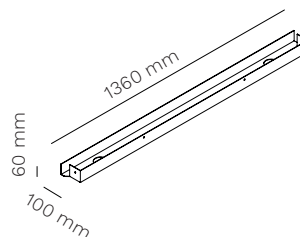

211V160



**Cable tray for table top
1600 mm**
Vasca portacavi per piani
da 1600 mm

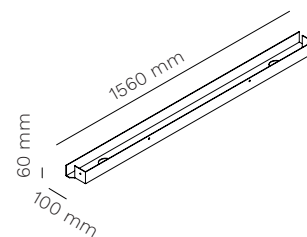

FRAME / STRUTTURA

powder coated steel
acciaio verniciato



296
textured
raggrinzato
RAL 9010



301
textured
raggrinzato
RAL 7044



444
textured
raggrinzato
RAL 8004



700
textured
raggrinzato
RAL 7000



203
textured
raggrinzato
RAL 6003



111
textured
raggrinzato
RAL 5011



333
textured
raggrinzato
RAL 3003



131
textured
raggrinzato
RAL 9006



148
textured
raggrinzato
RAL 7016



120
textured
raggrinzato
RAL 9005

TOP / PIANO

powder coated steel
acciaio verniciato



296
textured
raggrinzato
RAL 9010



301
textured
raggrinzato
RAL 7044



444
textured
raggrinzato
RAL 8004



700
textured
raggrinzato
RAL 7000



203
textured
raggrinzato
RAL 6003



111
textured
raggrinzato
RAL 5011



333
textured
raggrinzato
RAL 3003



131
textured
raggrinzato
RAL 9006



148
textured
raggrinzato
RAL 7016



120
textured
raggrinzato
RAL 9005

standard FENIX tops
piani standard in FENIX



0754
Blu
Fes



0791
Giallo
Evora



0751
Rosso
Jaipur



0750
Verde
Comodoro



0032
Bianco
Kos



0720
Nero
Ingo

STANDARDS AND CERTIFICATES / NORME E CERTIFICATI
Resistance to scratching EN 438-2:2019 - CL.25 Class ≥ 4 •
Resistance to staining EN 438-2:2019 - CL.26 Group 1 e 2: Class
5 Group 3: Class ≥ 4 • Resistance to dry heat (160°C/20') - EN
438-2:2019 - CL.16 Class 5 • Lightfastness (xenon arc) EN 438-
2:2019 - CL.27 Grayscale classification ≥ 4 • Resistance to steam

EN 438-2:2019 - CL.14 Class 5 • Specular surface reflection ISO
2813 8 ÷ 16 a 85° Unità Gloss • Resistance to surface wear EN
438-2:2019 - CL.10 Rotation value IP ≥ 200 • Resistance to damp
heat (100°C/20') - EN 438-2:2019 - CL.18 Class 5

TOP / PIANO

standard colour and material effect laminate tops

piani standard in laminato colore ed effetto materico



white
bianco



magnolia



light grey
grigio
chiaro



anthracite
antracite



black
nero



white marble
marmo
bianco



grey marble
marmo
grigio



graphite marble
marmo
grafite



black marble
marmo
nero



whitened oak
rovere
sbiancato



natural oak
rovere
naturale



grey oak
rovere
grigio



black oak
rovere
nero



walnut
noce



rose
rose



yellow
giallo



light blue
azzurro



green
verde

STANDARDS AND CERTIFICATES / NORME E CERTIFICATI

Dimensional tolerance related to the thickness $\pm 0,3$ mm • Dimensional tolerance related to the sizes $\pm 5,0$ mm • Resistance to scratching EN 438-2:2016 Class 3 • Resistance to staining EN 438-2:2016 Group 1 e 2: Class ≥ 4 Group 3: Class ≥ 4 • Resistance to dry heat (160°C/20') - EN 438-2 Class 4 • Lightfastness (xenon arc) EN 438-2 Grayscale classification ≥ 4

• Resistance to steam EN 438-2 Class 4 • Resistance to surface wear EN 438-2 Rotation value IP ≥ 150 • Resistance to damp heat (100°C/20') - EN 438-2 Class 4

standard colour and wood melamine tops

piani standard in nobilitato colore e legno



white
bianco



magnolia



light grey
grigio
chiaro



anthracite
antracite



black
nero



whitened oak
rovere
sbiancato



natural oak
rovere
naturale



grey oak
rovere
grigio



black oak
rovere
nero



walnut
noce

STANDARDS AND CERTIFICATES / NORME E CERTIFICATI

Dimensional tolerance related to the sizes $\pm 5,0$ mm • Resistance to scratching 1,5 N • Resistance to cigarette burning 3 grade - moderate change in gloss level and/or moderate brown spots • Resistance to surface wear Rotation value IP < 50 Rotation value WR < 150 • Risk of breakage ≥ 3 group • Dimensional tolerance related to the thickness $15 \leq X \leq 20$ mm : $\pm 0,3$ mm $X < 20$ mm : $\pm 0,5$ mm • Resistance to staining ≥ 3 group

• Resistance to steam 4 grade - moderate change in gloss level and/or color • Surface imperfections Prolate imperfections: < 20 mm/m Punctiform imperfections: < 2 mm²/m² • Lightfastness (xenon arc) > 6 group

CLEANING AND MAINTENANCE / PULIZIA E MANUTENZIONE

STEEL / ACCIAIO

en Our types of metals include: chromed metals and painted metals. Do not use acid or alkaline based cleaning products. Do not use detergents, steel wool, dishwashing detergents or the like. Sharp or pointed objects may damage the surface. Any hot or wet object may cause surface damage. Clean the surface regularly with a soft cloth to remove dust. To remove light dirt, use a soft cloth and a neutral household cleaner.

it Le nostre tipologie di metallo comprendono: metalli cromati e metalli verniciati. Non utilizzare prodotti per la pulizia a base acida o alcalina. Non utilizzare detergenti, lana di acciaio, detersivi per stoviglie o simili. Oggetti appuntiti o taglienti possono danneggiare la superficie. Qualsiasi oggetto caldo o bagnato potrebbe provocare danni alla superficie. Pulire la superficie regolarmente con un panno soffice per rimuovere la polvere. Per rimuovere lo sporco leggero utilizzare un panno soffice e un prodotto per le pulizie di casa neutro.

CHROMED STEEL AND ALUMINIUM POLISHED / ACCIAIO CROMATO E ALLUMINIO LUCIDO

en Do not use acid or alkaline based cleaning products. Do not use detergents, steel wool, dishwashing detergents or the like. Sharp or pointed objects may damage the surface. Any hot or wet object may cause surface damage. Clean the surface regularly with a soft cloth to remove dust. To remove light dirt, use a soft cloth and a neutral household cleaner

it Non utilizzare prodotti per la pulizia a base acida o alcalina. Non utilizzare detergenti, lana di acciaio, detersivi per stoviglie o simili. Oggetti appuntiti o taglienti possono danneggiare la superficie. Qualsiasi oggetto caldo o bagnato potrebbe provocare danni alla superficie. Pulire la superficie regolarmente con un panno soffice per rimuovere la polvere. Per rimuovere lo sporco leggero utilizzare un panno soffice e un prodotto per le pulizie di casa neutro.

LAMINATE AND MELAMINE / LAMINATI E NOBILITATI

en Laminates and melamine products guarantee high performance in terms of resistance to scratches, shocks and abrasions. Keep furniture away from direct sunlight; furniture in direct sunlight may tend to discolour over time. Do not use acid or alkaline based cleaning products. Sharp or pointed objects can damage the surface. Laminated and melamine furniture can be cleaned using a mixture of liquid soap and hot water. Rinse with cold water and dry with a paper towel or damp cloth.

it Laminati e nobilitati garantiscono alte prestazioni di resistenza ai graffi, agli urti e alle abrasioni. Mantenere i mobili lontani dalla luce diretta del sole; i mobili che si trovano alla luce diretta del sole potrebbero tendere a scolorire nel tempo. Non utilizzare prodotti per la pulizia a base acida o alcalina. Oggetti appuntiti o taglienti possono danneggiare la superficie. E' possibile effettuare la pulizia dei mobili in laminato e nobilitato usando una miscela di sapone liquido e acqua calda. Sciacquare con acqua fredda e asciugare con un tovagliolo di carta o un panno umido.

STANDARD FENIX TOPS / PIANI STANDARD IN FENIX

en Cleaning FENIX means cleaning its structure. You can do this with warm water. As FENIX is a strong material, you can also use any household cleaner – even solvents like acetone * if needed. However, to avoid damaging the structure, don't scrub it with abrasive cream, a scouring pad or a hard brush; in the long-term, this might lead to a glossy spot on your matt surface. Instead, you can use a melamine sponge – also known as a magic sponge. As a final step, to avoid anything staying behind in the structure – whether that's dirt or residue from your cleaner – always rinse afterward with warm water and wipe dry with a clean cloth.

* always follow safety instructions

it Pulire FENIX significa pulirne la struttura. Si può farlo, usando acqua tiepida. Poiché FENIX è un materiale resistente, si può utilizzare qualsiasi detergente per la casa, se necessario anche un solvente come l'acetone *. Tuttavia, per evitare di danneggiare la struttura, è consigliabile evitare di strofinarla usando una crema abrasiva, una spugna abrasiva o una spazzola con setole dure; nel tempo, ciò potrebbe portare alla formazione di un'area lucida sulla superficie opaca. Si può piuttosto utilizzare una spugna in melamina, nota anche come spugna magica. Come ultimo passaggio, per evitare la formazione di depositi nella struttura, che si tratti di sporco o residui del detergente, risciacquare sempre con acqua tiepida e asciugare con un panno pulito.

* seguire sempre le istruzioni di sicurezza.



en All the energy used in our company is 100% green and comes exclusively from renewable sources.

it Tutta l'energia utilizzata nella nostra azienda è 100% GREEN e proviene esclusivamente da fonti rinnovabili.

en As it is always seeking to improve its products, the company reserves the right to modify or upgrade the products without prior notice, at any time. Colors should be considered purely indicative. Mara's Collections are worldwide protected by the industrial property right and patents.

it Mara, sempre alla ricerca del miglioramento dei propri prodotti, si riserva la facoltà di apportare modifiche costruttive e funzionali in qualsiasi momento senza alcun preavviso. I colori dei materiali sono da ritenersi puramente indicativi. Tutte le collezioni Mara sono protette nel mondo dal diritto di proprietà industriale e da brevetti registrati.