

VEA SLED ARMCHAIR
5150

DESCRIPTION / DESCRIZIONE

en Vea is a versatile and contemporary seating collection that combines simple shapes with a wide choice of frames, colours and finishes.

The metal perimeter that perfectly follows the lines of the seat and backrest, strengthens the seat and creates an effect of refinement and essentiality.

Veá, also available in the upholstered versions, is ideal for tasteful furnishing contract, office and residential environments.

it Veá è una collezione di sedute versatile e contemporanea che combina la semplicità delle forme ad un'ampia scelta di telai, colori e finiture. Il perimetro metallico che segue le linee del sedile e dello schienale irrobustisce la seduta e crea un effetto raffinato ed essenziale.

Veá, disponibile anche imbottita, è ideale per arredare con gusto ambienti contract, ufficio e contesti residenziali.

VEA SLED ARMCHAIR

legs Ø 16 mm

gambe Ø 16 mm

5150

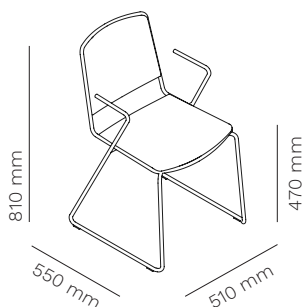

fire retardant polypropylene version
versione in polipropilene ignifugo



fire retardant upholsteries
rivestimenti ignifughi



CL1 IM*
*TEST IM
Fenice, Step
Melange



stackable up to 6 pcs
impilabile fino a 6 pezzi



4 VEA SLED ARMCHAIR / 5150	6,1 Kg	1 pc 0,48 mc	4 pcs / EU pallet 120x80x210h cm
-----------------------------------	---------------	------------------------	--

ACCESSORIES / ACCESSORI

3007



alignment links
agganci allineamento

3700B



block for alignment links
blocco agganci



upholstered seat and back
sedile e schienale imbottiti

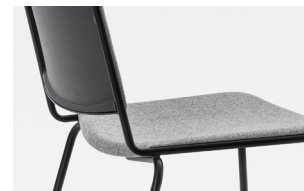

only upholstered seat
solo sedile imbottito

506



trolley (max 8 pcs)
carrello

VEA SLED ARMCHAIR

5150

mara[®]

SEAT AND BACK / SEDILE E SCHIENALE

polypropylene
polipropilene



315



370



302



365



330



325



315



370

fire retardant polypropylene
polipropilene ignifugo



FRAME / STRUTTURA

5-spoke aluminium base, on castors
base in alluminio a 5 razze, su ruote



296
textured
raggrinzato
RAL 9010



444
textured
raggrinzato
RAL 8004



700
textured
raggrinzato
RAL 7000



203
textured
raggrinzato
RAL 6003



120
textured
raggrinzato
RAL 9005



333
textured
raggrinzato
RAL 3003



111
textured
raggrinzato
RAL 5011



301
textured
raggrinzato
RAL 7044



131
textured
raggrinzato
RAL 9006



148
textured
raggrinzato
RAL 7016



aluminium
polished
alluminio
lucido

CLEANING AND MAINTENANCE / PULIZIA E MANUTENZIONE

STEEL / ACCIAIO

en Our types of metals include: chromed metals and painted metals. Do not use acid or alkaline based cleaning products. Do not use detergents, steel wool, dishwashing detergents or the like. Sharp or pointed objects may damage the surface. Any hot or wet object may cause surface damage. Clean the surface regularly with a soft cloth to remove dust. To remove light dirt, use a soft cloth and a neutral household cleaner.

it Le nostre tipologie di metallo comprendono: metalli cromati e metalli verniciati. Non utilizzare prodotti per la pulizia a base acida o alcalina. Non utilizzare detergenti, lana di acciaio, detersivi per stoviglie o simili. Oggetti appuntiti o taglienti possono danneggiare la superficie. Qualsiasi oggetto caldo o bagnato potrebbe provocare danni alla superficie. Pulire la superficie regolarmente con un panno soffice per rimuovere la polvere. Per rimuovere lo sporco leggero utilizzare un panno soffice e un prodotto per le pulizie di casa neutro.

CHROMED STEEL / ACCIAIO CROMATO

en Do not use acid or alkaline based cleaning products. Do not use detergents, steel wool, dishwashing detergents or the like. Sharp or pointed objects may damage the surface. Any hot or wet object may cause surface damage. Clean the surface regularly with a soft cloth to remove dust. To remove light dirt, use a soft cloth and a neutral household cleaner

it Non utilizzare prodotti per la pulizia a base acida o alcalina. Non utilizzare detergenti, lana di acciaio, detersivi per stoviglie o simili. Oggetti appuntiti o taglienti possono danneggiare la superficie. Qualsiasi oggetto caldo o bagnato potrebbe provocare danni alla superficie. Pulire la superficie regolarmente con un panno soffice per rimuovere la polvere. Per rimuovere lo sporco leggero utilizzare un panno soffice e un prodotto per le pulizie di casa neutro.

VEA SLED ARMCHAIR 5150

mara®

FIRE RETARDANT UPHOLSTERIES / RIVESTIMENTI IGNIFUGHI 

CAT. C, REMIX 3 - KVADRAT

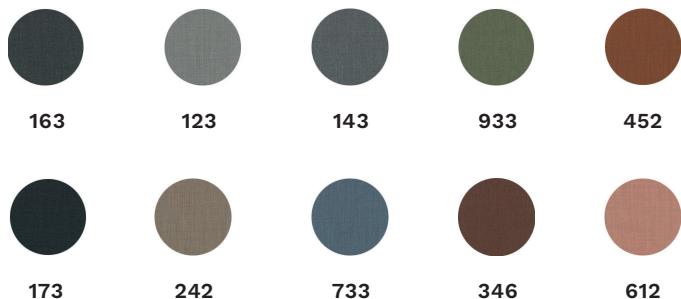

COMPOSITION / COMPOSIZIONE

90% new wool, 10% nylon

WEIGHT / PESO

420 g/lin.m, 13.6 oz/ly

ABRASION RESISTENCE / RESISTENZA ABRASIONE

100.000 Martindale rubs, EN ISO 12947

TEST IGNIFUGO / TEST IGNIFUGO

AS/NZS 1530.3 • BS 5852 crib 5 with treatment • BS 5852 part 1 • IMO FTP Code 2010 Part 7 with treatment • IMO FTP Code 2010 Part 8 • NF D 60 013 • NFPA 260 • SN 198 898 5.3 with treatment • UNI 9175 1IM • US Cal. Bull. 117-2013 • EN 1021-1/2 • AS/NZS 3837 class 2 • ÖNORM B1/Q1 • ASTM E84 Class A Unadhered • ASTM E84 Class A Adhered • GB 50222 B1 with treatment (Chinese) • EN 13501 B-s2, d0 with treatment

CLEANING RULES / NORME DI PULIZIA

Vacuum clean frequently, ideally every week. Remove stains as soon as they occur, with clean warm water or sparkling water. Extraction clean when necessary. Extraction cleaning might dissolve water-based glue. Pay attention to temperature and amount of cleaning fluid. Disinfection, see kvadrat.dk

Passare spesso l'aspirapolvere, possibilmente ogni settimana. Rimuovere le macchie non appena si formano, con acqua calda pulita o acqua calda o frizzante. Pulire a estrazione quando necessario. La pulizia a estrazione può sciogliere la colla a base d'acqua. Prestare attenzione alla temperatura e alla quantità di liquido detergente. Disinfezione, vedi kvadrat.dk

CAT. C, FIELD 2 - KVADRAT

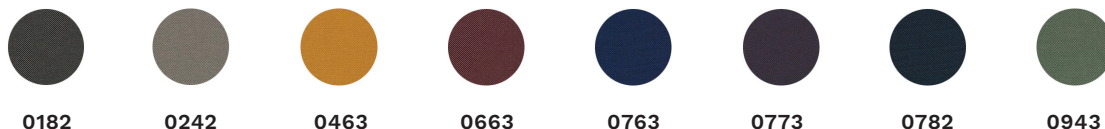

COMPOSITION / COMPOSIZIONE

100% Trevira CS

WEIGHT / PESO

450 g/lin. m (14.51 oz/ly)

ABRASION RESISTENCE / RESISTENZA ABRASIONE

80.000 Rubs Martindale (EN ISO 12947)

TEST IGNIFUGO / TEST IGNIFUGO

NF D 60 013 • US Cal. Bull. 117-2013 • NFPA 701 • BS 5852 Crib 5 • EN 1021-1/2 • AS/NZS 3837 class 1 • IMO FTP Code 2010 Part 8 • DIN 4102 B1 • NF P 92 507 M1 • FAR 25.853 • UNI 9175 1IM • UNI 9177 Classe 1 • BS 5867 part 2 type B • SN 198 898 5.2 • EN 13501-1, B-s1, d0 • ÖNORM B1/Q1 • CAN ULC S102 • CAN ULC S109 • IMO FTP Code 2010 Part 5 • GB 8624 B1 • ASTM E84 Class A Unadhered

CLEANING RULES / NORME DI PULIZIA

Vacuum clean frequently, ideally every week. Remove stains as soon as they occur, with clean warm water or sparkling water. Extraction clean when necessary. Extraction cleaning might dissolve water-based glue. Pay attention to temperature and amount of cleaning fluid. Disinfection, see kvadrat.dk

Passare spesso l'aspirapolvere, possibilmente ogni settimana. Rimuovere le macchie non appena si formano, con acqua calda pulita o acqua calda o frizzante. Pulire a estrazione quando necessario. La pulizia a estrazione può sciogliere la colla a base d'acqua. Prestare attenzione alla temperatura e alla quantità di liquido detergente. Disinfezione, vedi kvadrat.dk

VEA SLED ARMCHAIR 5150

mara®

CAT. C, CAPTURE - GABRIEL

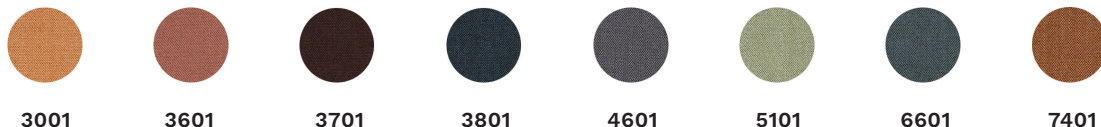

COMPOSITION / COMPOSIZIONE
85% New Zealand wool, 15% Polyamide

WEIGHT / PESO
475 g/lm — 15.32 oz/lin.yd

ABRASION RESISTENCE / RESISTENZA ABRASIONE
200,000 — rubs martindale (EN ISO 12947-2)
200,000 — rubs martindale (ASTM D4966) (heavy duty upholstery)

TEST IGNIFUGO / TEST IGNIFUGO
BS EN 1021 1&2 Cigarette and Match • BS 5852 Part 1 0,1 Cigarette & Match, The Furniture and Furnishing Regulations 1988 • Class Uno UNI 9175 Class 1 I EMME • CA TB 117-2013 • ASTM E 84 Class 1

**FIRE RETARDANT UPHOLSTERIES / RIVESTIMENTI
IGNIFUGHI**

CAT. C, CAPTURE - GABRIEL
4601 5101 6601 7401
3001 3601 3701 3801

CLEANING RULES / NORME DI PULIZIA
Always follow the manufacturer's instructions and finish by wiping with a damp cloth.

Seguire sempre le istruzioni del produttore e finire con un panno umido.

CAT. B, STEP MELANGE - GABRIEL

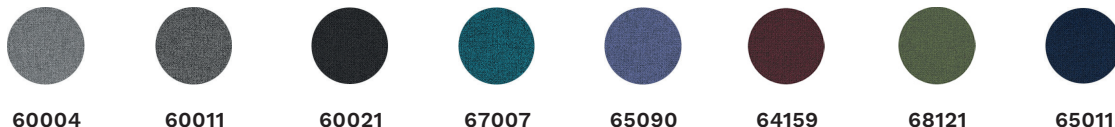

COMPOSITION / COMPOSIZIONE
100% Trevira cs

WEIGHT / PESO
470 g/lm, 15,16 oz/lin.yd

ABRASION RESISTENCE / RESISTENZA ABRASIONE
100.000 rubs martindale (EN ISO 12947-2), 100,000 double rubs wyzenbeek (ASTM D4157-07) (heavy duty upholstery)

FIRE RESISTANCE / RESISTENZA AL FUOCO
DIN 4102 - B1 • NFP 92-503/504/505 M1 • BS EN 1021 1&2 Cigarette and Match • BS EN 1021-1 Cigarette • BS 5852 Crib 5 • ÖNORM A3800-B1-B3825-Q1 UK • FAR/JAR 25.853 (a) (i) (ii) • AM 18 - NF D 60-013-(only for fabric) • CA TB 117-2013 • Class Uno UNI 9175 Class 1 I EMME • DIN EN 13501-1 B-s1,d0 • IMO MSC 307(88) Annex 1 part 8 • MED Certificate IMO • IMO MSC 307(88) Annex 1 part 8 UK • MED Certificate IMO UK • CAN/ULC-S102.2 • CAN/ULC-S 109

CLEANING RULES / NORME DI PULIZIA
Step Melange is made of Trevira CS which is a polyester material suited for environments with special requirements for cleaning. Can be wiped with Virkon S, Actichlor Plus, Prime Source ren-93 or Ethanol (70-85%). Always follow the manufacturer's instructions and finish by wiping with a damp cloth.

Step Melange è realizzato in Trevira CS, un materiale in poliesteri adatto ad ambienti con particolari esigenze di pulizia. Può essere pulito con Virkon S, Actichlor Plus, Prime Source ren-93 o etanolo (70-85%). Seguire sempre le istruzioni del produttore e finire con un panno umido.

VEA SLED ARMCHAIR 5150

mara[®]

CAT. B, FENICE - PUGI 

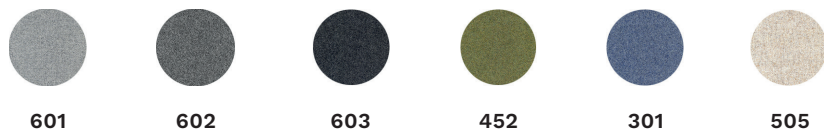

COMPOSITION / COMPOSIZIONE
75% WO 25% PA

WEIGHT / PESO
335 ± 7% / 500 ± 7% gr./m²-gr./mtl.

ABRASION RESISTENCE / RESISTENZA ABRASIONE
100.000 ± 20% cicli (UNI EN ISO 12947)

CERTIFICATIONS / CERTIFICAZIONI
Misura del coefficiente di assorbimento acustico UNI EN ISO 354:2003 • Rapporto di misura del coeff. di assorbimento acustico UNI EN ISO 10534-2 • Rapp.di Prova Classe 1IM- con schiuma standard ignifuga con densità 25 kg³ • BS 5852 Crib N°5 with standard Foam 20/22 Kg/cu.m-CON TRATT. A RICHIESTA • EN 1021 Part 1-2 using a standard Foam 20/22 Kg/cu.m. • Calif.Bull.117 June 2013

CLEANING RULES / NORME DI PULIZIA

Vacuum regularly with a smooth nozzle, without brushing.

Usare con regolarità l'aspirapolvere a beccuccio liscio, senza spazzolare.

CAT. A, MIRAGE - PUGI 

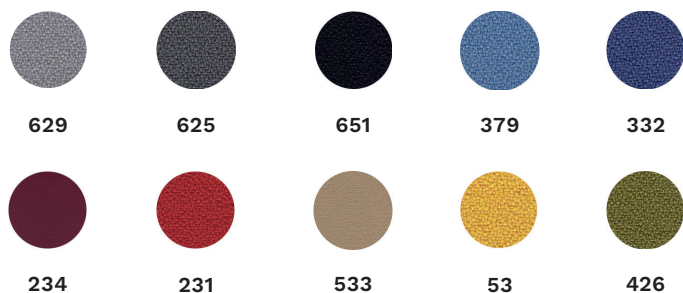

COMPOSITION / COMPOSIZIONE
100% PL FR (Tr Cs)

WEIGHT / PESO
330 ± 10% / 460 ± 10% gr./m²-gr./mtl.

ABRASION RESISTENCE / RESISTENZA ABRASIONE
100.000 ± 20% cicli (UNI EN ISO 12947:2000)

CERTIFICATIONS / CERTIFICAZIONI
Rapporto di misura della resistenza al flusso d'aria secondo la norma ISO 9053-2 • Classe 1 Sipari, Drappeggi, Tendaggi Classe 1 IM - Rapporto di prova • EN ISO 6940/6941: BS 5852 Crib N°5 using a CM Foam 35 Kg/cu.m. • B1 DIN 4102. • EN 1021 Part 1-2 using a CM Foam 35 Kg/cu.m. • EN 13773 Burning Behaviour: Class 1 • EN 13501-1 esp 1,2 : B-s1, • Calif.Bull.117 June 2013 • Fire Protection Classification: 5.3 • M1 + NF D 60-013:2006 AM18 • FAR.25853 Classification: yes • B1 - OENORM 3800 PART 1 + OENORM B3825 • Azimut • MED/3.19 MED/3.21: Draperies, Curtains and Bedding comp • MED annex A.1 item:A.1/3.20 Upholstered Furniture

CLEANING RULES / NORME DI PULIZIA

Vacuum regularly with a smooth nozzle, without brushing.

Usare con regolarità l'aspirapolvere a beccuccio liscio, senza spazzolare.



en All the energy used in our company is 100% green and comes exclusively from renewable sources.

it Tutta l'energia utilizzata nella nostra azienda è 100% GREEN e proviene esclusivamente da fonti rinnovabili.

en As it is always seeking to improve its products, the company reserves the right to modify or upgrade the products without prior notice, at any time. Colors should be considered purely indicative. Mara's Collections are worldwide protected by the industrial property right and patents.

it Mara, sempre alla ricerca del miglioramento dei propri prodotti, si riserva la facoltà di apportare modifiche costruttive e funzionali in qualsiasi momento senza alcun preavviso. I colori dei materiali sono da ritenersi puramente indicativi. Tutte le collezioni Mara sono protette nel mondo dal diritto di proprietà industriale e da brevetti registrati.