

250 CONE

250CONE, 250CONEL

mara[®]

DESCRIPTION / DESCRIZIONE

en 250 Cone is a table characterized by a conical base in powder coated steel, ideal for offices, restaurants and residential contexts. The top and the base feature a geometry that generates a sculptural element for interiors with the most varied formal expressions. The wide range of colours and finishes allows multiple combinations.

it 250 Cone è un tavolo fisso, caratterizzato da una base conica in acciaio verniciato, ideale per uffici, ristoranti e contesti residenziali. L'incontro di geometrie fra piano e supporto genera un elemento scultoreo per interni, dalle più variegata espressioni formali. L'ampia gamma di colori e finiture permette la personalizzazione dell'intera collezione in molteplici combinazioni.

250 CONE
fixed table
tavolo fisso

250CONE

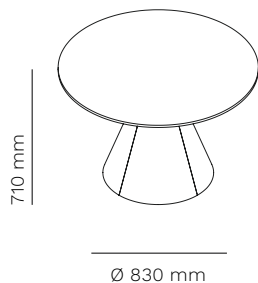

top
Ø 1400 - 1600 mm

250 CONE LARGE
fixed table
tavolo fisso

250CONEL

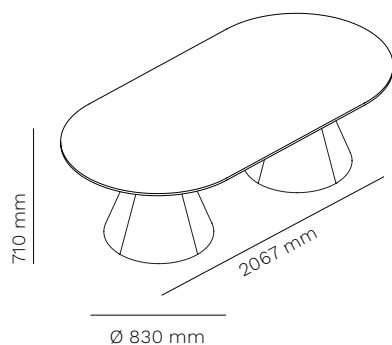

top
2600 - 3200 mm x 1400 - 1600 mm



**version with
FSC ® certified**
versione con piano
certificato FSC ®

INCLUDED ACCESSORIES / ACCESSORI INCLUSI

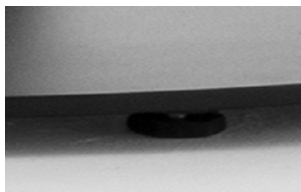

foot levelers
piedini livellatori

250 CONE
250CONE, 250CONEL

mara[®]

ACCESSORIES / ACCESSORI

PASD60



multifunctional sockets
Ø 60 mm
prese multifunzione
Ø 60 mm

PASD80



multifunctional sockets with wireless charging
Ø 80 mm
prese multifunzione con ricarica wireless Ø 80 mm

511PLUS



top access with flip cover
passacavi con sportello
only for (250CONEL)

511EPLUS



top access with multifunctional sockets
passacavi con prese multifunzione
only for (250CONEL)

FRAME / STRUTTURA

powder coated steel
acciaio verniciato



296 textured
raggrinzato
RAL 9010



301 textured
raggrinzato
RAL 7044



444 textured
raggrinzato
RAL 8004



700 textured
raggrinzato
RAL 7000



203 textured
raggrinzato
RAL 6003



111 textured
raggrinzato
RAL 5011



333 textured
raggrinzato
RAL 3003



131 textured
raggrinzato
RAL 9006



148 textured
raggrinzato
RAL 7016



120 textured
raggrinzato
RAL 9005

TOP / PIANO

standard FENIX tops
piani standard in FENIX



0754
Blu
Fes



0791
Giallo
Evora



0751
Rosso
Jaipur



0750
Verde
Comodoro



0032
Bianco
Kos



0720
Nero
Ingo

STANDARDS AND CERTIFICATES / NORME E CERTIFICATI
Resistance to scratching EN 438-2:2019 - CL.25 Class ≥ 4 •
Resistance to staining EN 438-2:2019 - CL.26 Group 1 e 2: Class 5 Group 3: Class ≥ 4 • Resistance to dry heat (160°C/20') - EN 438-2:2019 - CL.16 Class 5 • Lightfastness (xenon arc) EN 438-2:2019 - CL.27 Grayscale classification ≥ 4 • Resistance to steam

EN 438-2:2019 - CL.14 Class 5 • Specular surface reflection ISO 2813 8 ÷ 16 a 85° Unità Gloss • Resistance to surface wear EN 438-2:2019 - CL.10 Rotation value IP ≥ 200 • Resistance to damp heat (100°C/20') - EN 438-2:2019 - CL.18 Class 5

250 CONE
250CONE, 250CONEL

TOP / PIANO

standard colour and material effect laminate tops

piani standard in laminato colore ed effetto materico



white
bianco



magnolia



light grey
grigio
chiaro



anthracite
antracite



black
nero



white marble *
marmo
bianco



grey marble *
marmo
grigio



graphite marble
marmo
grafite



black marble
marmo
nero



whitened oak
rovere
sbiancato



natural oak
rovere
naturale



grey oak
rovere
grigio



black oak
rovere
nero



walnut
noce



rose *
rose



yellow *
giallo



light blue *
azzurro



green *
verde

* finishes available only for Ø 1200 mm tops
* finiture disponibili solo per piani Ø 1200 mm

STANDARDS AND CERTIFICATES / NORME E CERTIFICATI

Dimensional tolerance related to the thickness $\pm 0,3$ mm • Dimensional tolerance related to the sizes $\pm 5,0$ mm • Resistance to scratching EN 438-2:2016 Class 3 • Resistance to staining EN 438-2:2016 Group 1 e 2: Class ≥ 4 Group 3: Class ≥ 4 • Resistance to dry heat (160°C/20') - EN 438-2 Class 4 • Lightfastness (xenon arc) EN 438-2 Grayscale classification ≥ 4

• Resistance to steam EN 438-2 Class 4 • Resistance to surface wear EN 438-2 Rotation value IP ≥ 150 • Resistance to damp heat (100°C/20') - EN 438-2 Class 4

standard colour and wood melamine tops

piani standard in nobilitato colore e legno



white
bianco



magnolia



light grey
grigio
chiaro



anthracite
antracite



black
nero



whitened oak
rovere
sbiancato



natural oak
rovere
naturale



grey oak
rovere
grigio



black oak
rovere
nero



walnut
noce

STANDARDS AND CERTIFICATES / NORME E CERTIFICATI

Dimensional tolerance related to the sizes $\pm 5,0$ mm • Resistance to scratching 1,5 N • Resistance to cigarette burning 3 grade - moderate change in gloss level and/or moderate brown spots • Resistance to surface wear Rotation value IP < 50 Rotation value WR < 150 • Risk of breakage ≥ 3 group • Dimensional tolerance related to the thickness $15 \leq X \leq 20$ mm : $\pm 0,3$ mm $X < 20$ mm : $\pm 0,5$ mm • Resistance to staining ≥ 3 group

• Resistance to steam 4 grade - moderate change in gloss level and/or color • Surface imperfections Prolate imperfections: < 20 mm/m Punctiform imperfections: < 2 mm²/m² • Lightfastness (xenon arc) > 6 group

CLEANING AND MAINTENANCE / PULIZIA E MANUTENZIONE

STEEL / ACCIAIO

en Our types of metals include: chromed metals and painted metals. Do not use acid or alkaline based cleaning products. Do not use detergents, steel wool, dishwashing detergents or the like. Sharp or pointed objects may damage the surface. Any hot or wet object may cause surface damage. Clean the surface regularly with a soft cloth to remove dust. To remove light dirt, use a soft cloth and a neutral household cleaner.

it Le nostre tipologie di metallo comprendono: metalli cromati e metalli verniciati. Non utilizzare prodotti per la pulizia a base acida o alcalina. Non utilizzare detergenti, lana di acciaio, detersivi per stoviglie o simili. Oggetti appuntiti o taglienti possono danneggiare la superficie. Qualsiasi oggetto caldo o bagnato potrebbe provocare danni alla superficie. Pulire la superficie regolarmente con un panno soffice per rimuovere la polvere. Per rimuovere lo sporco leggero utilizzare un panno soffice e un prodotto per le pulizie di casa neutro.

LAMINATE AND MELAMINE / LAMINATI E NOBILITATI

en Laminates and melamine products guarantee high performance in terms of resistance to scratches, shocks and abrasions. Keep furniture away from direct sunlight; furniture in direct sunlight may tend to discolour over time. Do not use acid or alkaline based cleaning products. Sharp or pointed objects can damage the surface. Laminate and melamine furniture can be cleaned using a mixture of liquid soap and hot water. Rinse with cold water and dry with a paper towel or damp cloth.

it Laminati e nobilitati garantiscono alte prestazioni di resistenza ai graffi, agli urti e alle abrasioni. Mantenere i mobili lontani dalla luce diretta del sole; i mobili che si trovano alla luce diretta del sole potrebbero tendere a scolorire nel tempo. Non utilizzare prodotti per la pulizia a base acida o alcalina. Oggetti appuntiti o taglienti possono danneggiare la superficie. E' possibile effettuare la pulizia dei mobili in laminato e nobilitato usando una miscela di sapone liquido e acqua calda. Sciacquare con acqua fredda e asciugare con un tovagliolo di carta o un panno umido.

STANDARD FENIX TOPS / PIANI STANDARD IN FENIX

en Cleaning FENIX means cleaning its structure. You can do this with warm water. As FENIX is a strong material, you can also use any household cleaner – even solvents like acetone * if needed. However, to avoid damaging the structure, don't scrub it with abrasive cream, a scouring pad or a hard brush; in the long-term, this might lead to a glossy spot on your matt surface. Instead, you can use a melamine sponge – also known as a magic sponge. As a final step, to avoid anything staying behind in the structure – whether that's dirt or residue from your cleaner – always rinse afterward with warm water and wipe dry with a clean cloth.

* always follow safety instructions

it Pulire FENIX significa pulirne la struttura. Si può farlo, usando acqua tiepida. Poiché FENIX è un materiale resistente, si può utilizzare qualsiasi detergente per la casa, se necessario anche un solvente come l'acetone *. Tuttavia, per evitare di danneggiare la struttura, è consigliabile evitare di strofinarla usando una crema abrasiva, una spugna abrasiva o una spazzola con setole dure; nel tempo, ciò potrebbe portare alla formazione di un'area lucida sulla superficie opaca. Si può piuttosto utilizzare una spugna in melamina, nota anche come spugna magica. Come ultimo passaggio, per evitare la formazione di depositi nella struttura, che si tratti di sporco o residui del detergente, risciacquare sempre con acqua tiepida e asciugare con un panno pulito.
* seguire sempre le istruzioni di sicurezza.

TOP ACCESS WITH INTEGRATED MULTIFUNCTIONAL SOCKET

PASSACAVI CON MULTIPRESA INTEGRATA

PASD60

mara®

DESCRIPTION / DESCRIZIONE

en Top access round with integrated multifunctional socket for table tops, available in white or black colours, diameter 60 mm with 1,5 mt. power cable + 1 DE + 1 USB 5V/2, 4A socket.

it Presa multifunzione rotonda per piani tavoli, disponibile nei colori bianco o nero, diametro 60 mm con 1,5 mt. di cavo di alimentazione + 1 presa DE + 1 presa USB 5V/2, 4A.



Optional (on demand)*:
Opzionali (su richiesta)*:

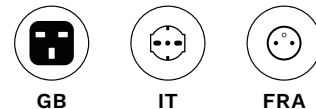

* dedicated quotation / quotazione dedicata

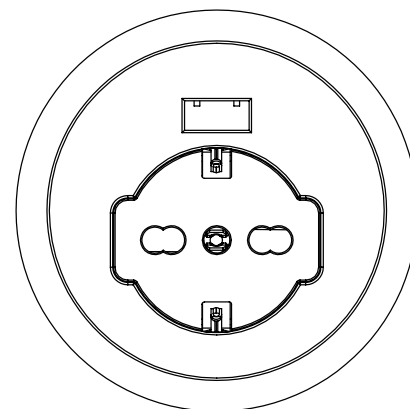
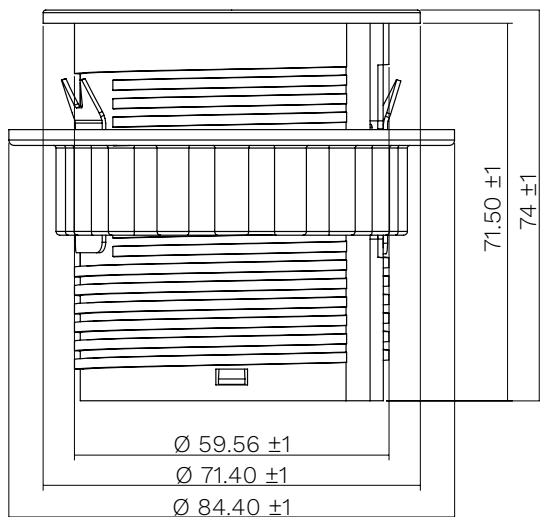

Surface cut-out area

Area di taglio della superficie

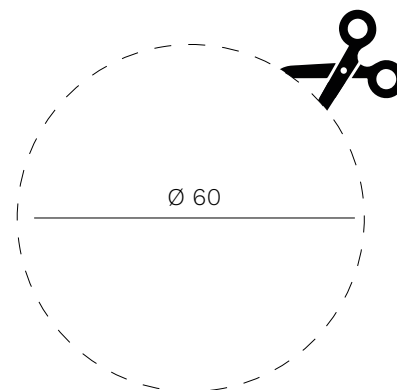

All measurements are indicated in mm
Tutte le misure sono indicate in mm

COLOURS AVAILABLE / COLORI DISPONIBILI



white
bianco



black
nero



CABLE MANAGEMENT WITH INTEGRATED MULTISOCKET PASSACAPO CON MULTIPRESA INTEGRATA

mara[®]

PASD80

DESCRIPTION / DESCRIZIONE

en Top access round with integrated multifunctional socket for table tops, available in white or black colours, diameter 80 mm with 2 mt. power cable + 1 DE + 2 USB 5V/2, 4A socket + 1 RJ45 (interchangeable). The inside of the cover is equipped with a wireless charger (usable only when open).

it Presa multifunzione rotonda per piani tavoli, disponibile nei colori bianco o nero, diametro 80 mm con 2 mt. di cavo di alimentazione + 1 presa DE + 2 prese USB 5V/2, 4A + 1 presa RJ45 (intercambiabile). L'interno del coperchio è provvisto di caricatore wireless (utilizzabile solo quando aperto).



wireless recharge

RJ45

DE

USB

1

Optional (on demand)*:
Opzionali (su richiesta)*:



HDMI



EXIT



GB



IT



FRA

* dedicated quotation and minimum order
* quotazione dedicata e minimo d'ordine

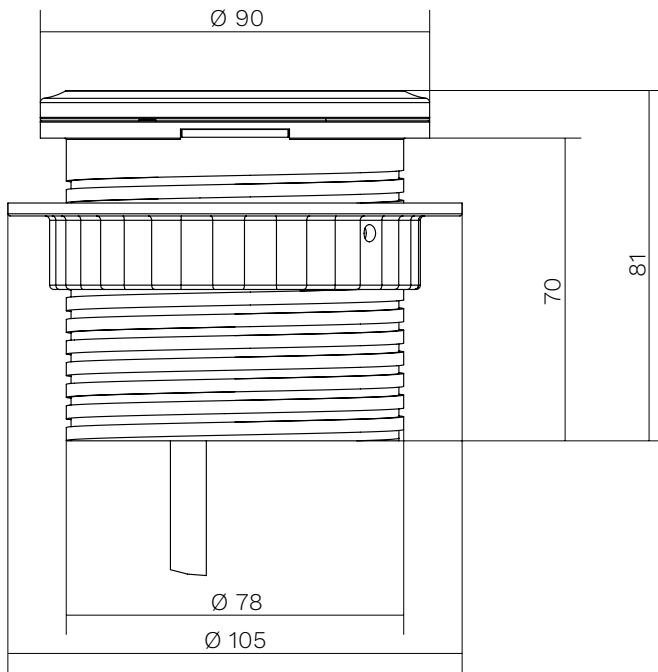

All measurements are indicated in mm
Tutte le misure sono indicate in mm

COLOURS AVAILABLE / COLORI DISPONIBILI



white
bianco



black
nero

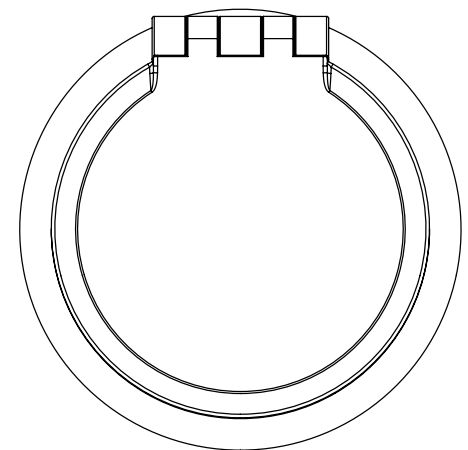

Surface cut-out area
Area di taglio della superficie

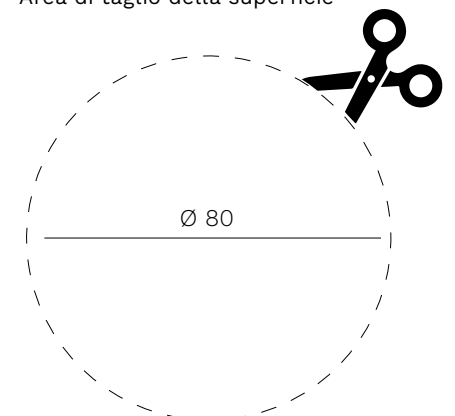

REV122024

MARA SRL | Via Adua 11, 25050 Passirano (BS) Italy | T. +39 030 6857568 | marasrl.it

TOP ACCESS

PASSACAVI

511PLUS

mara®

DESCRIPTION / DESCRIZIONE

en Aluminium top access with flap. Black brush.

it Passacavi in alluminio con spazzola nera.



1

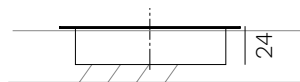
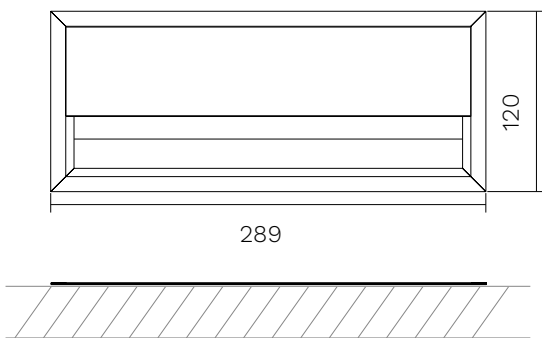

All measurements are indicated in mm
Tutte le misure sono indicate in mm

Surface cut-out area

Area di taglio della superficie

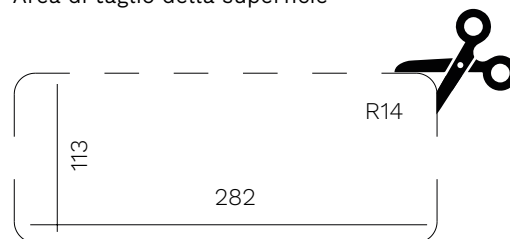

COLOURS AVAILABLE / COLORI DISPONIBILI



aluminium
alluminio



black
nero



TOP ACCESS WITH INTEGRATED POWER UNIT
PASSACAVI CON MULTIPRESA INTEGRATA

mara[®]

511EPLUS

DESCRIPTION / DESCRIZIONE

en Top access with integrated power unit for table tops max 30 mm thick, available in aluminium or black colour, 289x120 mm with 2 mt. power cable + 2 DE sockets + 2 USB 5V/2, 4A + 2 RJ45 sockets.

it Passacavo con multipresa integrata per piani tavoli spessore max 30 mm, disponibile nei colori alluminio o nero, 289x120 mm con 2 mt. di cavo di alimentazione + 2 presa DE + 2 prese USB 5V/2, 4A + 2 prese RJ45.



RJ45



DE



USB



1

Optional (on demand)*:
 Opzionali (su richiesta)*:



HDMI



IT



FRA

* dedicated quotation / quotazione dedicata

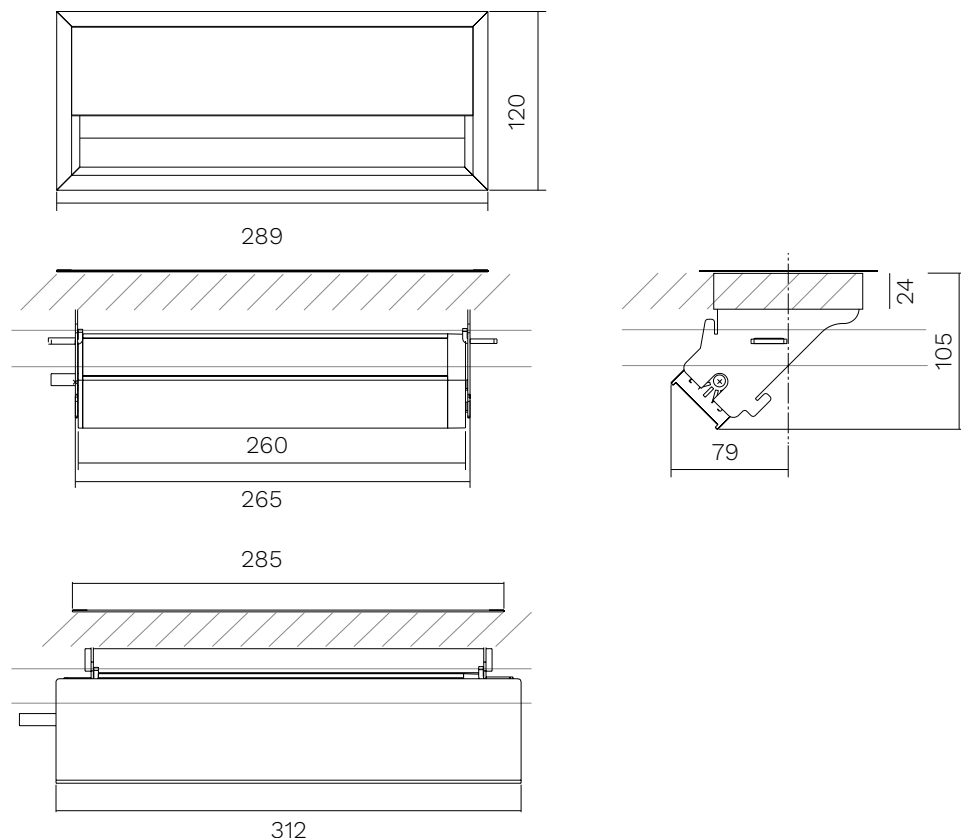

Surface cut-out area

Area di taglio della superficie

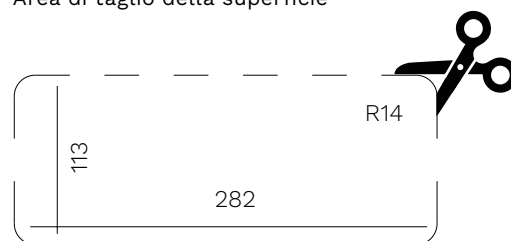

All measurements are indicated in mm
 Tutte le misure sono indicate in mm

COLOURS AVAILABLE / COLORI DISPONIBILI

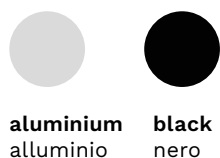



en All the energy used in our company is 100% green and comes exclusively from renewable sources.

it Tutta l'energia utilizzata nella nostra azienda è 100% GREEN e proviene esclusivamente da fonti rinnovabili.

en As it is always seeking to improve its products, the company reserves the right to modify or upgrade the products without prior notice, at any time. Colors should be considered purely indicative. Mara's Collections are worldwide protected by the industrial property right and patents.

it Mara, sempre alla ricerca del miglioramento dei propri prodotti, si riserva la facoltà di apportare modifiche costruttive e funzionali in qualsiasi momento senza alcun preavviso. I colori dei materiali sono da ritenersi puramente indicativi. Tutte le collezioni Mara sono protette nel mondo dal diritto di proprietà industriale e da brevetti registrati.