

ARGO LIBRO
286, 286XL



DESCRIPTION / DESCRIZIONE

en Argo Libro is a space saving table of big dimensions that can be fold in 40 cm. Available in a wide range of sizes, including the XL version for table tops up to 1200 mm deep, can be used during conferences, meetings, workgroups and trainings, whilst giving the location an ample usage flexibility. The mechanical folding system makes this table easy to move by one person alone. Once closed it can pass with ease through doors and elevators and can be placed in small storages as well. The table is equipped with the exclusive antishock system, designed and patented by Mara, which is able to keep the user's hands safe when opening the table. Argo Libro and Argo Libro XL are CATAS UNI EN 15372:2016 certified, which proves its robustness, reliability and security.

it Argo Libro è un tavolo salvaspazio di grandi dimensioni richiudibile in soli 40 cm. Disponibile in un'ampia gamma di dimensioni, tra cui la versione XL per piani profondi fino a 1200 mm, può essere usato per conferenze, riunioni, meeting, lavori di gruppo e training, donando agli spazi un'ampia flessibilità d'utilizzo. Il sistema di chiusura meccanico rende questo tavolo facilmente manovrabile da una persona sola. Una volta richiuso passa con facilità da porte e ascensori e può essere riposto anche in piccoli ambienti. Argo Libro è dotato dell'esclusivo sistema anti shock brevettato Mara, che mantiene in totale sicurezza le mani dell'utente durante l'apertura del tavolo. Argo Libro e Argo Libro XL sono certificati CATAS UNI EN 15372:2016 a dimostrazione della loro robustezza, affidabilità e sicurezza.

ARGO LIBRO
folding table on castors
tavolo pieghevole su ruote

286 Small / 286 Large

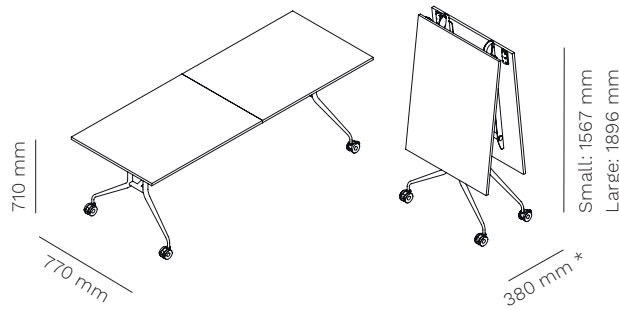

top
Small: 2000 - 2600 x 800 - 1000 mm
Large: 2800 - 3200 x 800 - 1000 mm

* with tops: min 400 mm - max 480 mm

286XL Small / 286XL Large

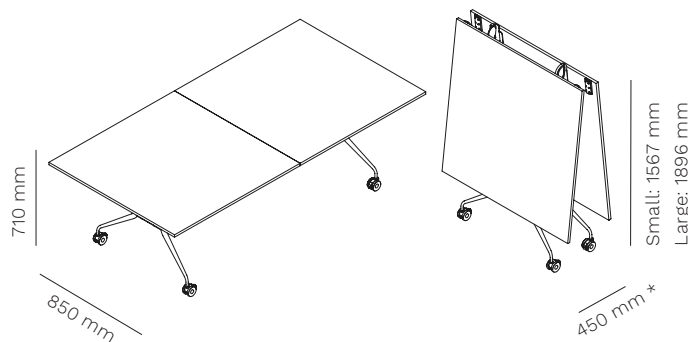

top
Small: 2000 - 2600 x 900 - 1200 mm
Large: 2800 - 3200 x 900 - 1200 mm

* with tops: min 500 mm - max 550 mm



patented system
sistema brevettato



UNI EN 15372:2016



stackable
impilabile



version with FSC® certified top
versione con piano certificato FSC®



frame delivered assembled
telaio fornito montato



1 FRAME (286 Small) 1 TELAIO (286 Small)	33 kg	1 pc 0,65 mc	1 pc / EU pallet 120x80x185h cm
			2 pcs / EU pallet 130x110x185h cm
1 FRAME (286 Large) 1 TELAIO (286 Large)	37 kg	1 pc 0,79 mc	1 pc / EU pallet 120x80x185h cm
			2 pcs / EU pallet 130xw110x185h cm
1 FRAME (286XL Small) 1 TELAIO (286XL Small)	43 kg	1 pc 0,80 mc	1 pc / EU pallet 120x80x185h cm
			2 pcs / EU pallet 130x110x185h cm
1 FRAME (286XL Large) 1 TELAIO (286XL Large)	47 kg	1 pc 0,97 mc	1 pc / EU pallet 120x80x185h cm
			2 pcs / EU pallet 130x110x185h cm

ARGO LIBRO
286, 286XL



AVAILABLE TOPS / PIANI DISPONIBILI

286 Small tops
286 Small piani

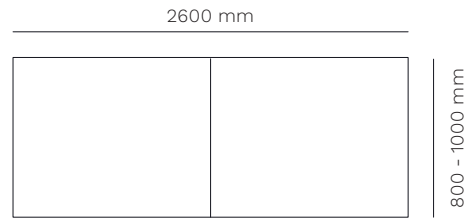
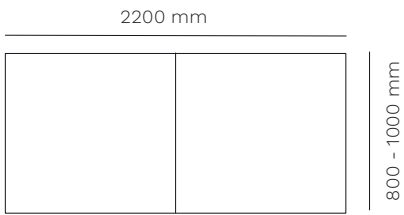
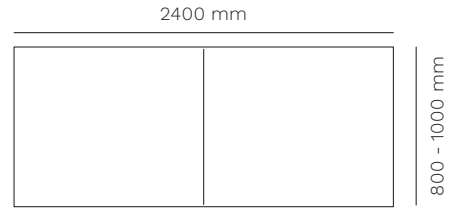
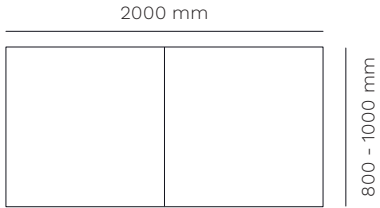

286 Large tops
286 Large piani

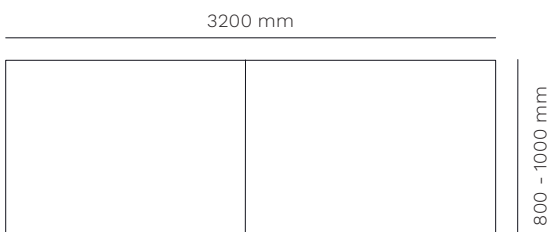
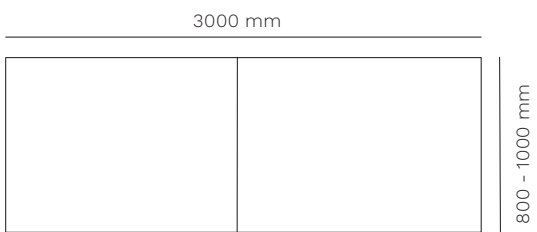
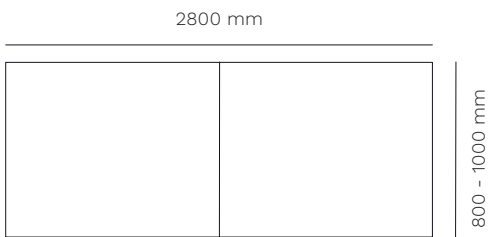

ARGO LIBRO
286, 286XL



AVAILABLE TOPS / PIANI DISPONIBILI

286XL Small tops
286XL Small piani

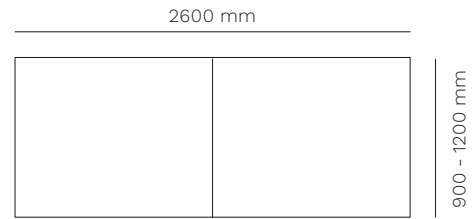
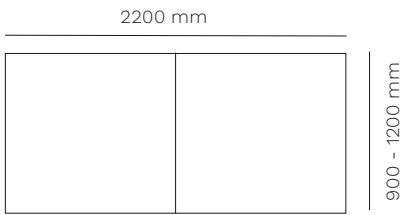
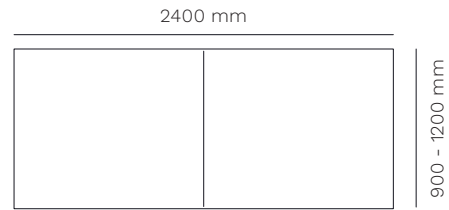
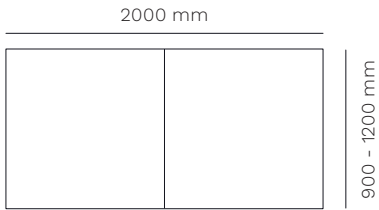

286XL Large tops
286XL Large piani

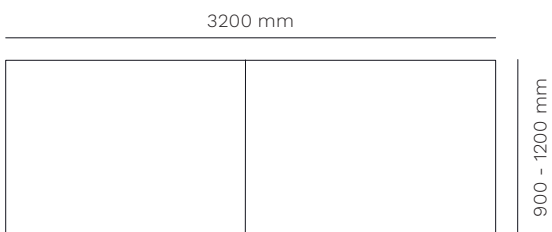
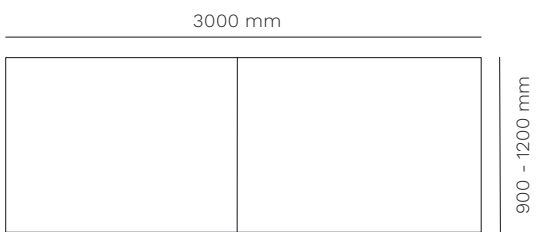
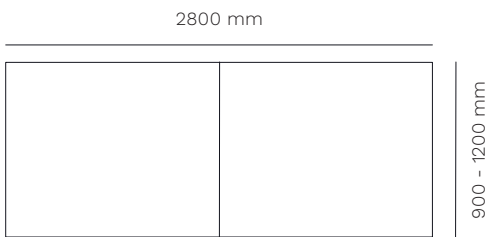

AVAILABLE TOPS / PIANI DISPONIBILI

286 Small tops with round angles
286 Small piani con angoli smussati

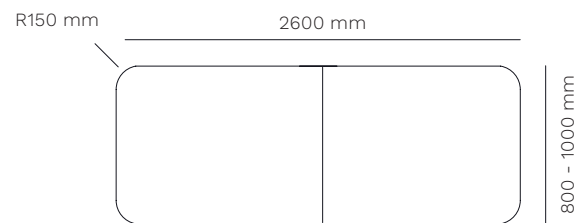
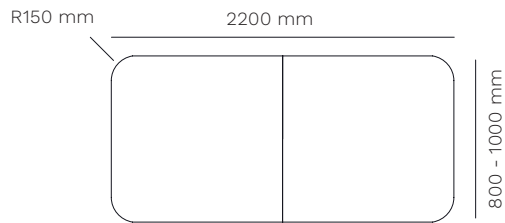
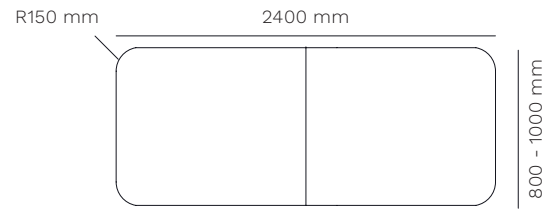
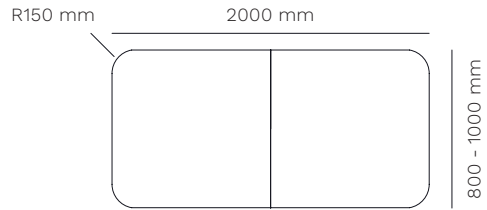

286 Large tops with round angles
286 Large piani con angoli smussati

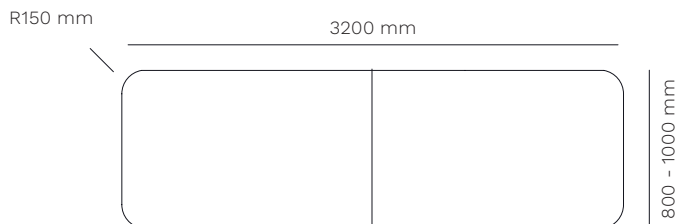
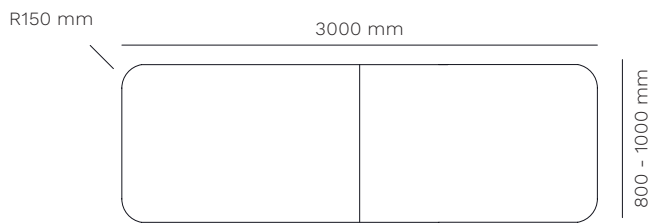
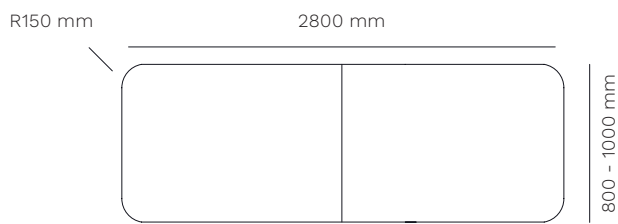

ARGO LIBRO
286, 286XL



AVAILABLE TOPS / PIANI DISPONIBILI

286XL Small tops with round angles
286XL Small piani con angoli smussati

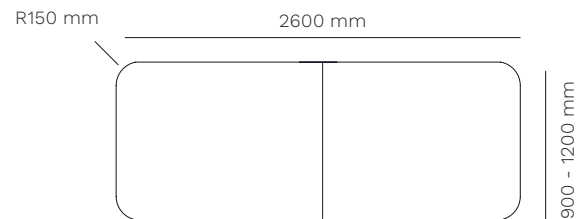
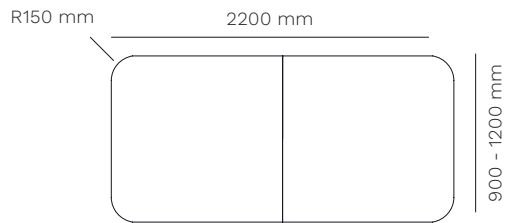
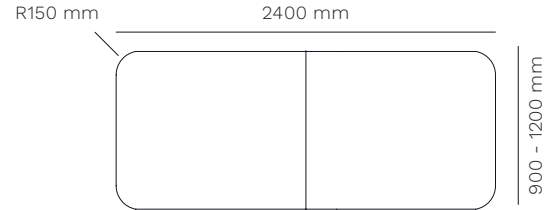
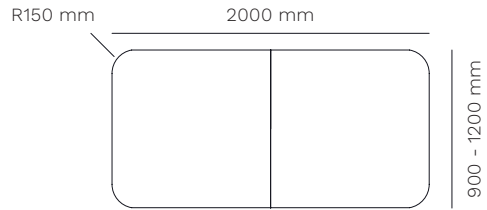

286XL Large tops with round angles
286XL Large piani con angoli smussati

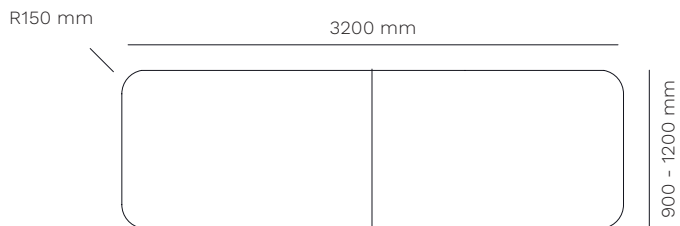
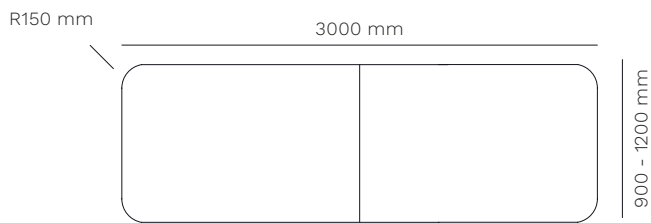
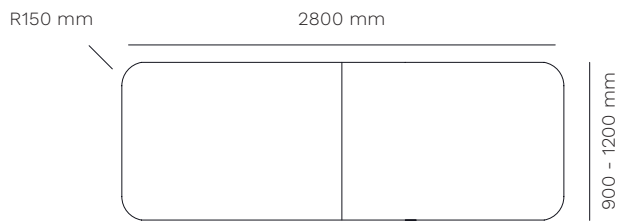

ARGO LIBRO
286, 286XL

AVAILABLE TOPS / PIANI DISPONIBILI

286 Small barrel tops
286 Small piani a botte

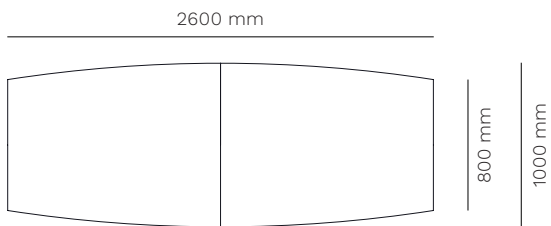
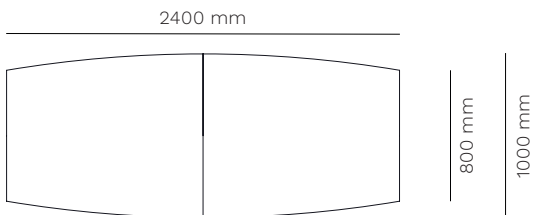
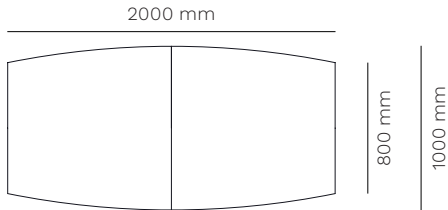

286 Large barrel tops
286 Large piani a botte

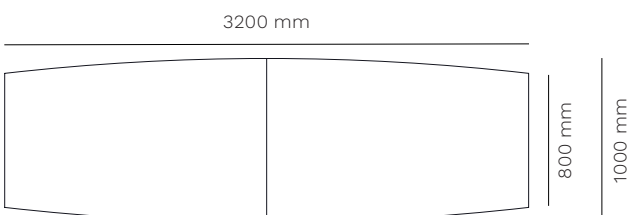
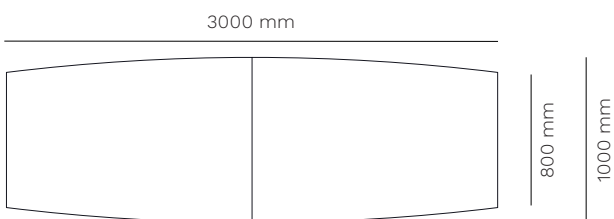
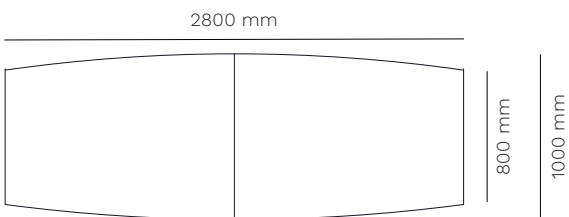

ARGO LIBRO
286, 286XL

AVAILABLE TOPS / PIANI DISPONIBILI

286XL Small barrel tops
286XL Small piani a botte

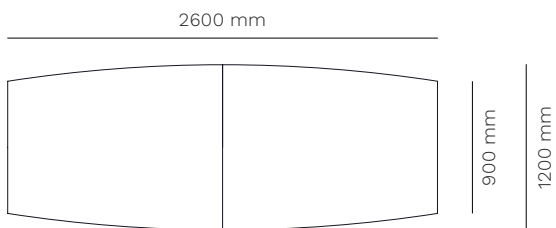
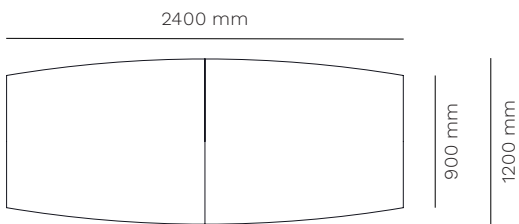
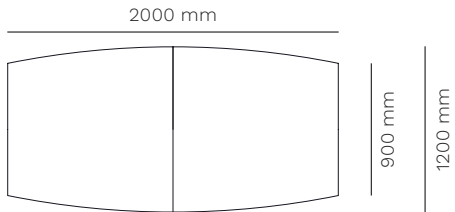

286XL Large barrel tops
286XL Large piani a botte

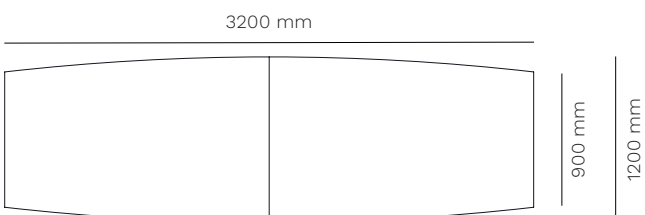
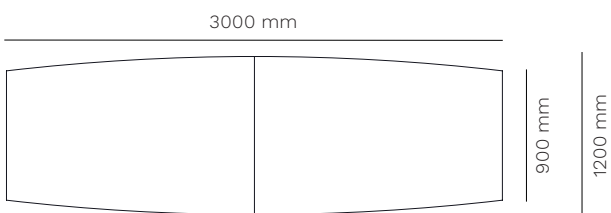
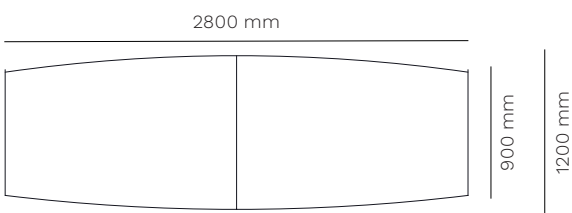

ARGO LIBRO
286, 286XL

mara[®]

INCLUDED ACCESSORIES / ACCESSORI INCLUSI



antishock system
sistema antishock



locking system and tops alignment
sistema di chiusura e allineamento piani

K075



kit of 4 castors Ø 75 mm with integrated brakes
kit 4 ruote Ø 75 mm con freni integrati

ACCESSORIES / ACCESSORI

511PLUS



top access with flip cover
passacavi con sportello

511EPLUS



top access with multifunctional sockets
passacavi con prese multifunzione

PASD60



multifunctional sockets Ø 60 mm
prese multifunzione Ø 60 mm

PASD80



multifunctional sockets with wireless charging Ø 80 mm
prese multifunzione con ricarica wireless Ø 80 mm

215KIT



nylon kit for connection
agganci in nylon

350P



plastic cables-fixer for table top
portacavi in plastica per piano

500DROLL



mobile storage system, on castors
cassettera mobile su ruote

300

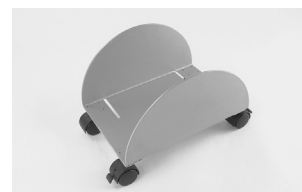

cpu holder
portaserver

K100 *



kit of 4 castors Ø 100 mm with integrated brakes
kit 4 ruote Ø 100 mm con freni integrati

*** the table will be 25 mm higher**
* il tavolo si alzerà di 25 mm

ARGO LIBRO

286, 286XL

mara®

FRAME / STRUTTURA

powder coated steel
acciaio verniciato



chromed steel
acciaio cromato



eco chrome
cromo ecologico

TOP / PIANO

standard FENIX tops
piani standard in FENIX



STANDARDS AND CERTIFICATES / NORME E CERTIFICATI
Resistance to scratching EN 438-2:2019 - CL.25 Class ≥ 4 •
Resistance to staining EN 438-2:2019 - CL.26 Group 1 e 2: Class 5 Group 3: Class ≥ 4 • Resistance to dry heat (160°C/20') - EN 438-2:2019 - CL.16 Class 5 • Lightfastness (xenon arc) EN 438-2:2019 - CL.27 Grayscale classification ≥ 4 • Resistance to steam

EN 438-2:2019 - CL.14 Class 5 • Specular surface reflection ISO 2813 8 ÷ 16 a 85° Unità Gloss • Resistance to surface wear EN 438-2:2019 - CL.10 Rotation value IP ≥ 200 • Resistance to damp heat (100°C/20') - EN 438-2:2019 - CL.18 Class 5

TOP / PIANO

standard colour and material effect laminate tops

piani standard in laminato colore ed effetto materico



white
bianco



magnolia



light grey
grigio
chiaro



anthracite
antracite



black
nero



white marble
marmo
bianco



grey marble
marmo
grigio



graphite marble
marmo
grafite



black marble
marmo
nero



whitened oak
rovere
sbiancato



natural oak
rovere
naturale



grey oak
rovere
grigio



black oak
rovere
nero



walnut
noce



rose
rose



yellow
giallo



light blue
azzurro



green
verde

STANDARDS AND CERTIFICATES / NORME E CERTIFICATI

Dimensional tolerance related to the thickness $\pm 0,3$ mm • Dimensional tolerance related to the sizes $\pm 5,0$ mm • Resistance to scratching EN 438-2:2016 Class 3 • Resistance to staining EN 438-2:2016 Group 1 e 2: Class ≥ 4 Group 3: Class ≥ 4 • Resistance to dry heat (160°C/20') - EN 438-2 Class 4 • Lightfastness (xenon arc) EN 438-2 Grayscale classification ≥ 4

• Resistance to steam EN 438-2 Class 4 • Resistance to surface wear EN 438-2 Rotation value IP ≥ 150 • Resistance to damp heat (100°C/20') - EN 438-2 Class 4

standard colour and wood melamine tops

piani standard in nobilitato colore e legno



white
bianco



magnolia



light grey
grigio
chiaro



anthracite
antracite



black
nero



whitened oak
rovere
sbiancato



natural oak
rovere
naturale



grey oak
rovere
grigio



black oak
rovere
nero



walnut
noce

STANDARDS AND CERTIFICATES / NORME E CERTIFICATI

Dimensional tolerance related to the sizes $\pm 5,0$ mm • Resistance to scratching 1,5 N • Resistance to cigarette burning 3 grade - moderate change in gloss level and/or moderate brown spots • Resistance to surface wear Rotation value IP < 50 Rotation value WR < 150 • Risk of breakage ≥ 3 group • Dimensional tolerance related to the thickness $15 \leq X \leq 20$ mm : $\pm 0,3$ mm X < 20 mm : $\pm 0,5$ mm • Resistance to staining ≥ 3 group

• Resistance to steam 4 grade - moderate change in gloss level and/or color • Surface imperfections Prolate imperfections: < 20 mm/m Punctiform imperfections: < 2 mm²/m² • Lightfastness (xenon arc) > 6 group

CLEANING AND MAINTENANCE / PULIZIA E MANUTENZIONE

STEEL / ACCIAIO

en Our types of metals include: chromed metals and painted metals. Do not use acid or alkaline based cleaning products. Do not use detergents, steel wool, dishwashing detergents or the like. Sharp or pointed objects may damage the surface. Any hot or wet object may cause surface damage. Clean the surface regularly with a soft cloth to remove dust. To remove light dirt, use a soft cloth and a neutral household cleaner.

it Le nostre tipologie di metallo comprendono: metalli cromati e metalli verniciati. Non utilizzare prodotti per la pulizia a base acida o alcalina. Non utilizzare detergenti, lana di acciaio, detersivi per stoviglie o simili. Oggetti appuntiti o taglienti possono danneggiare la superficie. Qualsiasi oggetto caldo o bagnato potrebbe provocare danni alla superficie. Pulire la superficie regolarmente con un panno soffice per rimuovere la polvere. Per rimuovere lo sporco leggero utilizzare un panno soffice e un prodotto per le pulizie di casa neutro.

CHROMED STEEL AND ALUMINIUM POLISHED / ACCIAIO CROMATO E ALLUMINIO LUCIDO

en Do not use acid or alkaline based cleaning products. Do not use detergents, steel wool, dishwashing detergents or the like. Sharp or pointed objects may damage the surface. Any hot or wet object may cause surface damage. Clean the surface regularly with a soft cloth to remove dust. To remove light dirt, use a soft cloth and a neutral household cleaner

it Non utilizzare prodotti per la pulizia a base acida o alcalina. Non utilizzare detergenti, lana di acciaio, detersivi per stoviglie o simili. Oggetti appuntiti o taglienti possono danneggiare la superficie. Qualsiasi oggetto caldo o bagnato potrebbe provocare danni alla superficie. Pulire la superficie regolarmente con un panno soffice per rimuovere la polvere. Per rimuovere lo sporco leggero utilizzare un panno soffice e un prodotto per le pulizie di casa neutro.

LAMINATE AND MELAMINE / LAMINATI E NOBILITATI

en Laminates and melamine products guarantee high performance in terms of resistance to scratches, shocks and abrasions. Keep furniture away from direct sunlight; furniture in direct sunlight may tend to discolour over time. Do not use acid or alkaline based cleaning products. Sharp or pointed objects can damage the surface. Laminate and melamine furniture can be cleaned using a mixture of liquid soap and hot water. Rinse with cold water and dry with a paper towel or damp cloth.

it Laminati e nobilitati garantiscono alte prestazioni di resistenza ai graffi, agli urti e alle abrasioni. Mantenere i mobili lontani dalla luce diretta del sole; i mobili che si trovano alla luce diretta del sole potrebbero tendere a scolorire nel tempo. Non utilizzare prodotti per la pulizia a base acida o alcalina. Oggetti appuntiti o taglienti possono danneggiare la superficie. E' possibile effettuare la pulizia dei mobili in laminato e nobilitato usando una miscela di sapone liquido e acqua calda. Sciacquare con acqua fredda e asciugare con un tovagliolo di carta o un panno umido.

STANDARD FENIX TOPS / PIANI STANDARD IN FENIX

en Cleaning FENIX means cleaning its structure. You can do this with warm water. As FENIX is a strong material, you can also use any household cleaner – even solvents like acetone * if needed. However, to avoid damaging the structure, don't scrub it with abrasive cream, a scouring pad or a hard brush; in the long-term, this might lead to a glossy spot on your matt surface. Instead, you can use a melamine sponge – also known as a magic sponge. As a final step, to avoid anything staying behind in the structure – whether that's dirt or residue from your cleaner – always rinse afterward with warm water and wipe dry with a clean cloth.

* always follow safety instructions

it Pulire FENIX significa pulirne la struttura. Si può farlo, usando acqua tiepida. Poiché FENIX è un materiale resistente, si può utilizzare qualsiasi detergente per la casa, se necessario anche un solvente come l'acetone *. Tuttavia, per evitare di danneggiare la struttura, è consigliabile evitare di strofinarla usando una crema abrasiva, una spugna abrasiva o una spazzola con setole dure; nel tempo, ciò potrebbe portare alla formazione di un'area lucida sulla superficie opaca. Si può piuttosto utilizzare una spugna in melamina, nota anche come spugna magica. Come ultimo passaggio, per evitare la formazione di depositi nella struttura, che si tratti di sporco o residui del detergente, risciacquare sempre con acqua tiepida e asciugare con un panno pulito.

* seguire sempre le istruzioni di sicurezza.

KIT OF NYLON LINKS/HOOKS FOR TOP CONNECTION

KIT AGGANCI IN NYLON PER COLLEGAMENTO PIANI

mara[®]

215KIT

DESCRIPTION / DESCRIZIONE

en Nylon kit that makes it easy to connect two tables.

it Kit agganci in nylon che permette con facilità di unire due tavoli.

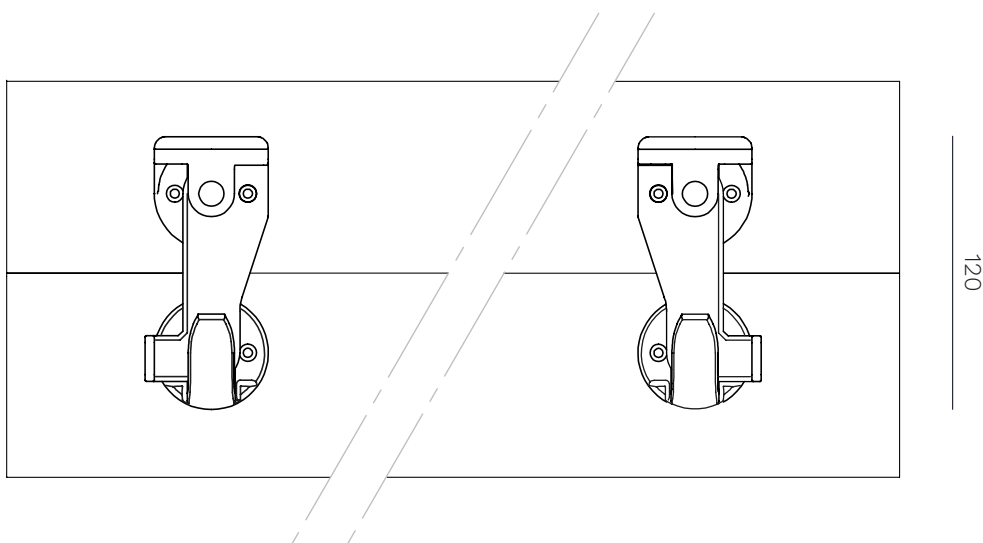

Drilling pattern:

Schema di foratura:

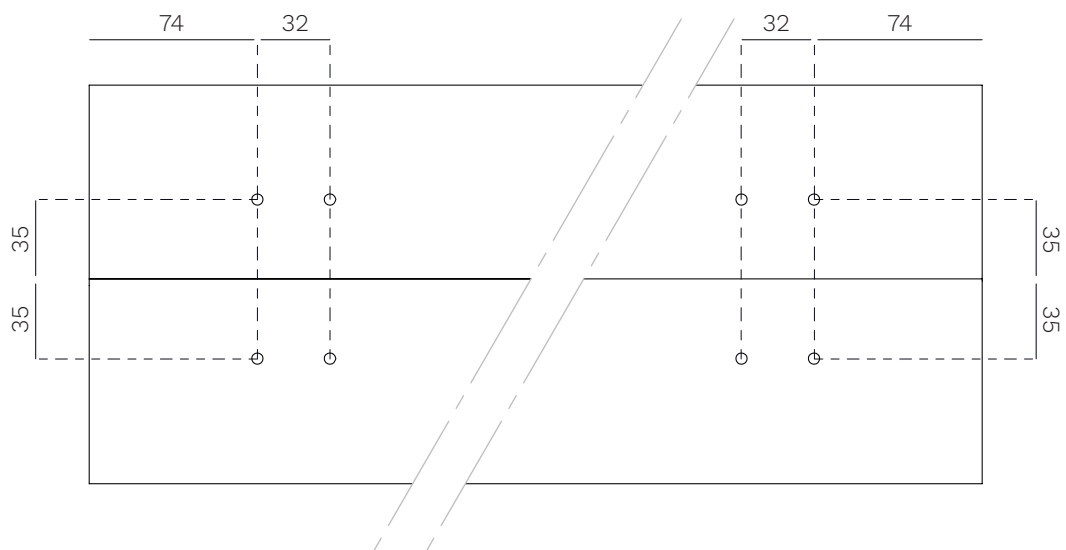

All measurements are indicated in mm
Tutte le misure sono indicate in mm

COLOURS AVAILABLE / COLORI DISPONIBILI



black
nero



TOP ACCESS

PASSACAVI

511PLUS

mara®

DESCRIPTION / DESCRIZIONE

en Aluminium top access with flap. Black brush.

it Passacavi in alluminio con spazzola nera.



1

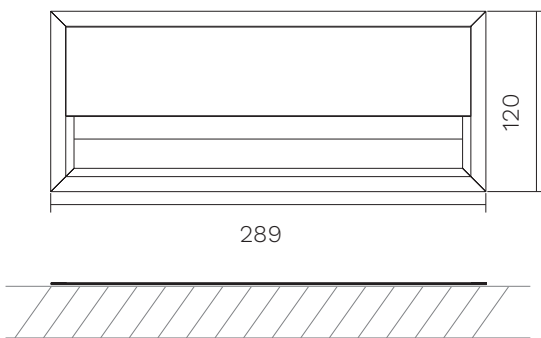

All measurements are indicated in mm
Tutte le misure sono indicate in mm

Surface cut-out area

Area di taglio della superficie

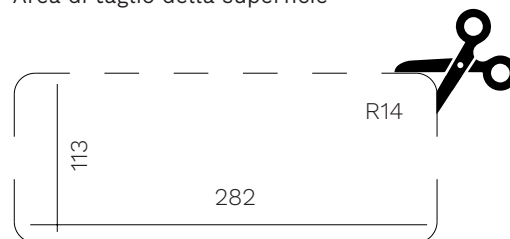

COLOURS AVAILABLE / COLORI DISPONIBILI



aluminium
alluminio



black
nero



TOP ACCESS WITH INTEGRATED POWER UNIT
PASSACAVI CON MULTIPRESA INTEGRATA



511EPLUS

DESCRIPTION / DESCRIZIONE

en Top access with integrated power unit for table tops max 30 mm thick, available in aluminium or black colour, 289x120 mm with 2 mt. power cable + 2 DE sockets + 2 USB 5V/2, 4A + 2 RJ45 sockets.

it Passacavo con multipresa integrata per piani tavoli spessore max 30 mm, disponibile nei colori alluminio o nero, 289x120 mm con 2 mt. di cavo di alimentazione + 2 presa DE + 2 prese USB 5V/2, 4A + 2 prese RJ45.

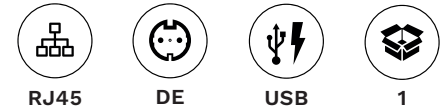

Optional (on demand)*:
 Opzionali (su richiesta)*:

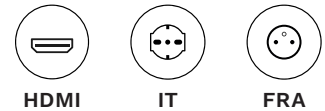

* dedicated quotation / quotazione dedicata

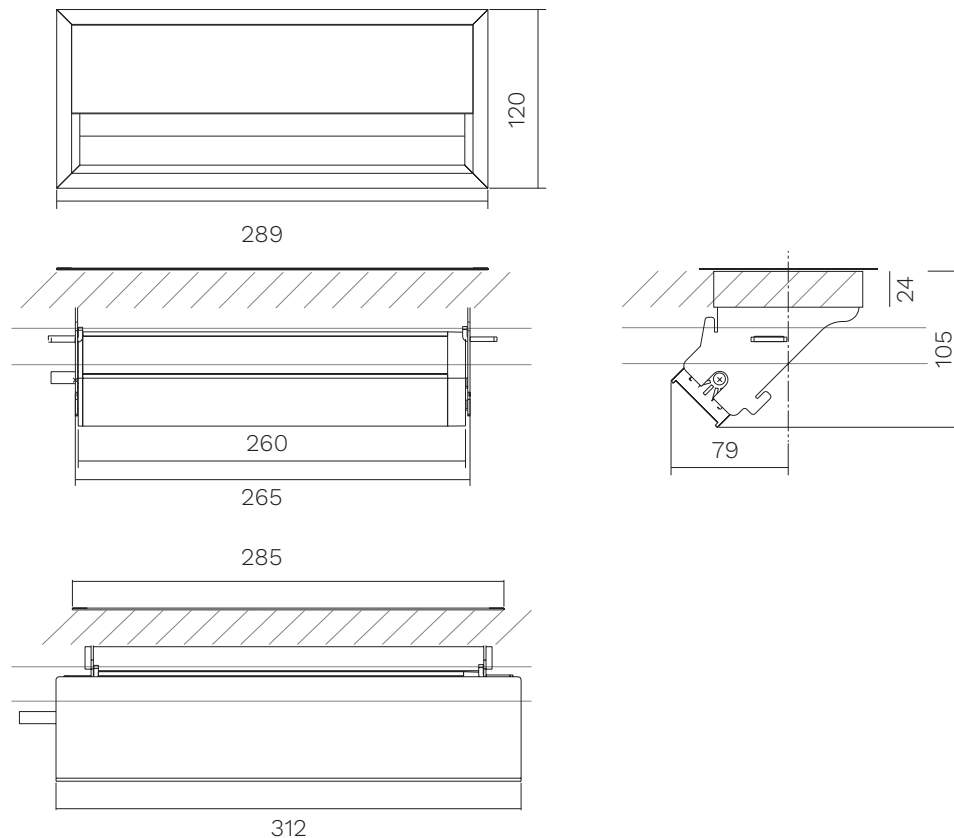

Surface cut-out area
 Area di taglio della superficie

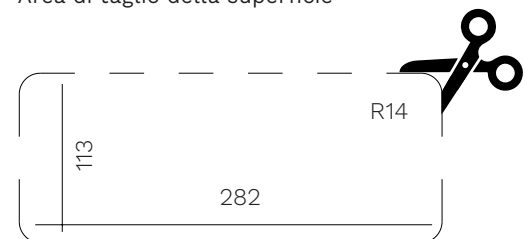

All measurements are indicated in mm
 Tutte le misure sono indicate in mm

COLOURS AVAILABLE / COLORI DISPONIBILI

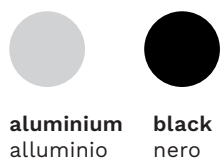

TOP ACCESS WITH INTEGRATED MULTIFUNCTIONAL SOCKET

PASSACAVI CON MULTIPRESA INTEGRATA

mara®

PASD60

DESCRIPTION / DESCRIZIONE

en Top access round with integrated multifunctional socket for table tops, available in white or black colours, diameter 60 mm with 1,5 mt. power cable + 1 DE + 1 USB 5V/2, 4A socket.

it Presa multifunzione rotonda per piani tavoli, disponibile nei colori bianco o nero, diametro 60 mm con 1,5 mt. di cavo di alimentazione + 1 presa DE + 1 presa USB 5V/2, 4A.



Optional (on demand)*:
Opzionali (su richiesta)*:

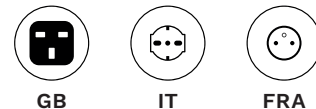

* dedicated quotation / quotazione dedicata

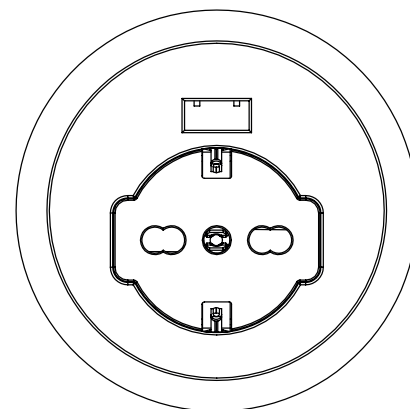
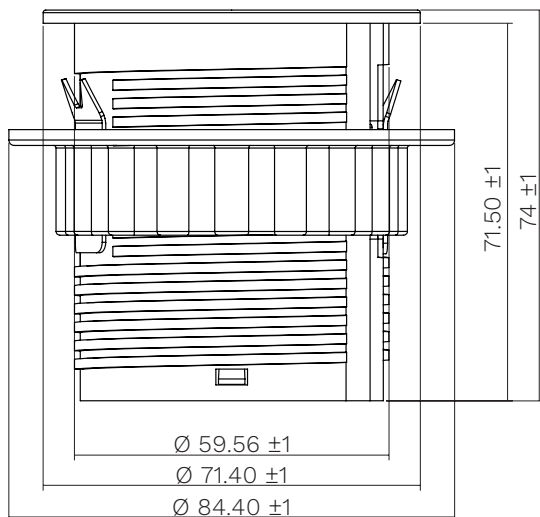

Surface cut-out area

Area di taglio della superficie

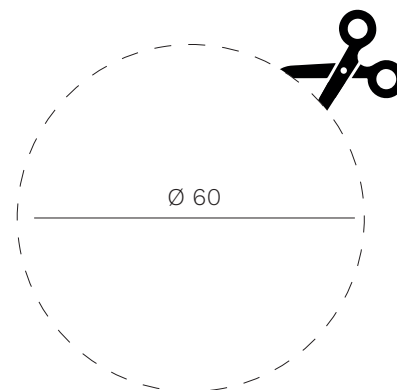

All measurements are indicated in mm
Tutte le misure sono indicate in mm

COLOURS AVAILABLE / COLORI DISPONIBILI



white
bianco



black
nero



CABLE MANAGEMENT WITH INTEGRATED MULTISOCKET PASSACAPO CON MULTIPRESA INTEGRATA

mara[®]

PASD80

DESCRIPTION / DESCRIZIONE

en Top access round with integrated multifunctional socket for table tops, available in white or black colours, diameter 80 mm with 2 mt. power cable + 1 DE + 2 USB 5V/2, 4A socket + 1 RJ45 (interchangeable). The inside of the cover is equipped with a wireless charger (usable only when open).

it Presa multifunzione rotonda per piani tavoli, disponibile nei colori bianco o nero, diametro 80 mm con 2 mt. di cavo di alimentazione + 1 presa DE + 2 prese USB 5V/2, 4A + 1 presa RJ45 (intercambiabile). L'interno del coperchio è provvisto di caricatore wireless (utilizzabile solo quando aperto).



wireless recharge

RJ45

DE

USB

1

Optional (on demand)*:
Opzionali (su richiesta)*:



HDMI



EXIT



GB



IT



FRA

* dedicated quotation and minimum order
* quotazione dedicata e minimo d'ordine

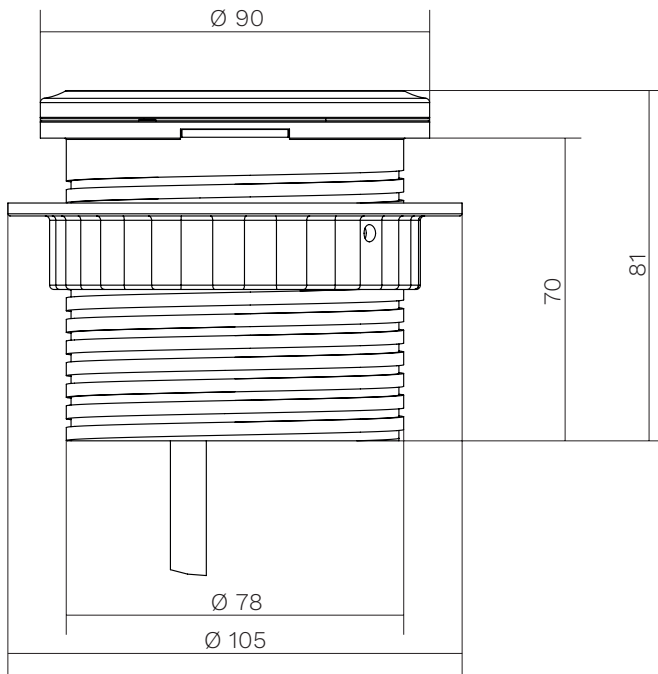

All measurements are indicated in mm
Tutte le misure sono indicate in mm

COLOURS AVAILABLE / COLORI DISPONIBILI



white
bianco



black
nero

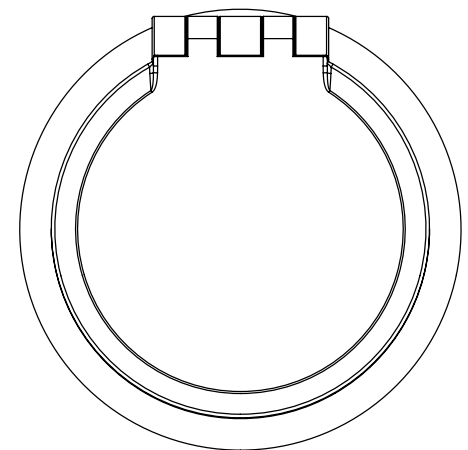

Surface cut-out area
Area di taglio della superficie

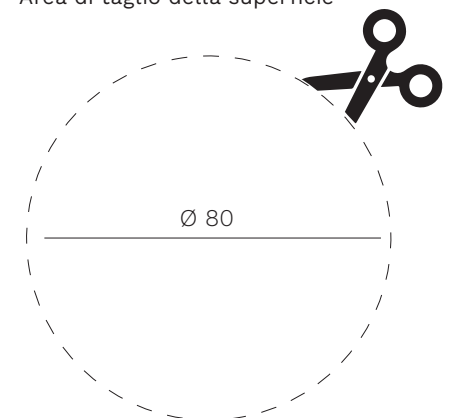



en All the energy used in our company is 100% green and comes exclusively from renewable sources.

it Tutta l'energia utilizzata nella nostra azienda è 100% GREEN e proviene esclusivamente da fonti rinnovabili.

en As it is always seeking to improve its products, the company reserves the right to modify or upgrade the products without prior notice, at any time. Colors should be considered purely indicative. Mara's Collections are worldwide protected by the industrial property right and patents.

it Mara, sempre alla ricerca del miglioramento dei propri prodotti, si riserva la facoltà di apportare modifiche costruttive e funzionali in qualsiasi momento senza alcun preavviso. I colori dei materiali sono da ritenersi puramente indicativi. Tutte le collezioni Mara sono protette nel mondo dal diritto di proprietà industriale e da brevetti registrati.